



POWERED BY CARLSBRO

Carlsbro Holdings Ltd

Unit 11, Torc MK, Chippenham Drive, Milton Keynes,
MK10 0BZ, United Kingdom

Tel: +44(0)1908 281072

Web: www.carlsbro.com Email: sales@carlsbro.com

EDA 50

drum amplifier

IMPORTANT SAFETY SYMBOLS



The symbol is used to indicate that some hazardous live terminals are involved within this apparatus, even under the normal operating conditions, which may be sufficient to constitute the risk of electric shock or death.



The symbol is used in the service documentation to indicate that specific component shall be replaced only by the component specified in that documentation for safety reasons.



Protective grounding terminal



Alternating current/voltage



Hazardous live terminal

ON: Denotes the apparatus is turned on.

OFF: Denotes the apparatus is turned off.

WARNING: Describes precautions that should be observed to prevent the danger of injury or death to the operator.

CAUTION: Describes precautions that should be observed to prevent danger of the apparatus.



Use only with the cart, stand, tripod, bracket, or table specified by the manufacturer, or sold with the apparatus. When a cart is used, use caution when moving the cart/apparatus combination to avoid injury from tip-over.

IMPORTANT SAFETY INSTRUCTIONS

Read these instructions. Keep these instructions.

Heed all warning. Follow all instructions.

Water & Moisture

The apparatus should be protected from moisture and rain, can not used near water, for example: near bathtub, kitchen sink or a swimming pool, etc.

Heat

The apparatus should be located away from the heat source such as radiators, stoves or other appliances that produce heat.

EDA 50 drum amplifier

EDA 50 TOP PANEL

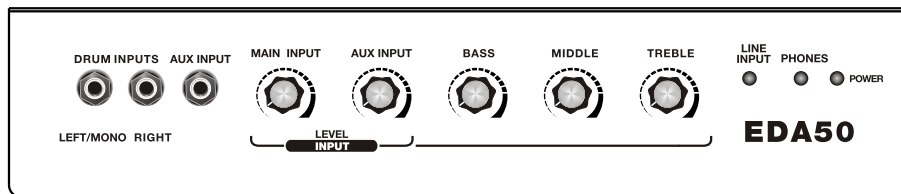

DRUM INPUTS:

These are 1/4" input jacks (left and right).when using a mono signal, plug into the left/mono jack.

AUX INPUT:

This jack is used for connecting any pre-EQ source such as a click track. The volume of the Aux Input is controlled by the Aux Volume control.

MAIN INPUT:

Use this control to adjust DRUM INPUTS level.

AUX INPUT:

Use this control to adjust AUX INPUT level.

BASS:

Use this control to adjust the low frequency level of signal.

MIDDLE:

Use this control to adjust the middle frequency level of signal.

TREBLE:

Use this control to adjust the high frequency level of signal.

LINE INPUT:

This is to connect with MP3 or any audio source for playing along as accompany.

PHONES:

This is to connect with headphones for silent practice.

POWER:

Power "on" Indicator.

EDA 50 drum amplifier

EDA 50 REAR PANEL

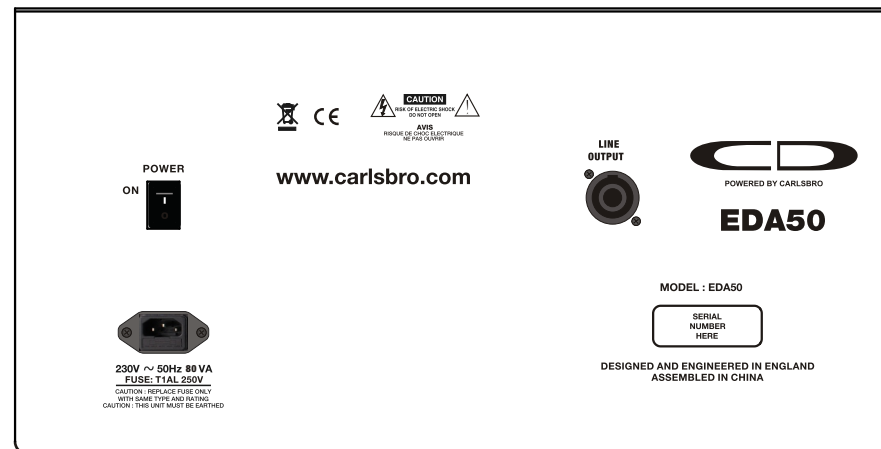

POWER:

Use this switch to turn the amplifier on and off.

LINE OUTPUT:

Line signals output to connect another AMP.

TECHNICAL DATA

*Power: 50W/ 8 Ohm

*Input impedance: 10K Ohms

*Input sensitivity : -10dBV

*High: 10KHZ \pm 12dB

Middle: 800HZ \pm 12dB

Low : 60HZ \pm 12dB

*speaker: 10"/ 8ohm for woofer

2"/8ohm for tweeter

*Consumption power: 80W

*Dimension(HxWxD): 400x395x390mm

*Weight : 15.3kg



177.607 **PD CONNEX**

CX120-3 Guitar Cable 6.3 Mono - 6.3 Mono 3m

PD Connex professional HQ 3 meter 6,3 Jack (mono) guitar cable. This flexible guitar cable is fitted with high quality metal Jack connectors and guarantees a trouble-free and reliable signal transmission. Supplied including cable tie.

Select both plugs : 6.3 mm jack (mono) (M)
Lead length : 3m
Conductor : 20x0.12mm
Outer diameter : 6mm
Shielding : 64x0.12mm
Weight (kg) : 0,19

- Professional flexible cable
- High quality metal connectors
- Cable tie included
- Various lengths available



177.780 **VONYX**

CX336-3 Cable 3.5mm Stereo Male - 3.5mm Stereo Male 3m

A 3 meter 3,5mm Jack stereo (M) - 3,5mm Jack stereo (M) signal cable. This flexible signal cable is fitted with Jack connectors and guarantees a trouble-free and reliable signal transmission.

Select both plugs : 3.5 mm jack (stereo) (M)

Lead length : 3m

Conductor : 10x0.12mm

Outer diameter : 4mm

Shielding : 36x0.12mm

Weight (kg) : 0,10

- Flexible cable (Jack)
- Various lengths available



CSD45M
OWNER'S MANUAL

Congratulations!

Thank you for purchasing this Carlsbro digital drum set. This drum set has been developed to act and play like an acoustic drum set but with greater ease and much lower volume. Before you use the instrument, we recommend that you take the time to carefully read through this user guide, to familiarise yourself with the controls and get the best out of your new drum set. It also contains important safety information and practical hints and tips to perfectly setup and configure your drum set.

Taking care of your digital drum set

Location

- Please set up your drum set in a spacious area on a carpet or rug where available.
- Do not expose the unit to the following conditions to avoid deformation, discolouration or more serious damage:

Direct sunlight, high temperatures, next to a heat source, in a car during the day time or in a cold, damp environment.

Power supply

- Make sure to use a correct AC adaptor and that the AC outlet voltage of your country matches the input voltage specified on the AC adaptor, and label on the underside of the sound module.
- Turn the power switch OFF when the Instrument is not in use.
- The AC adaptor should be unplugged from the AC outlet if the instrument is not to be used for an extended period of time.
- Unplug the AC adaptor during electrical storms.
- Avoid plugging the AC adaptor into the same AC outlet as appliances with high power consumption, such as electric heaters or ovens.
- Try to avoid using multi-plug adaptors as these can result in a reduction of sound quality, operational errors, and possibly damage.

Turn power OFF when making connections

- To avoid damage to the instrument and connected devices, turn the power switches of all related devices OFF prior to connecting or disconnecting any cables.

Handling and transport

- Never apply excessive force to the controls, buttons, connectors or other parts of the instrument.
- Always unplug cables by gripping the plug firmly, not by pulling on the cable.
- Disconnect all cables before moving the instrument.
- Physical shocks caused by dropping, bumping, or placing heavy objects on the instrument will result in scratches and more serious damage.
- Do not disassemble any components or try to analyse any internal parts by yourself. There are no user-serviceable parts for this drum set. If any malfunction occurs during use, stop using it and refer to the trouble shooting page towards the end of this user guide.

Cleaning

- Unplug the power plug before cleaning this drum set. Do not touch the power plug with wet hands or materials.
- Clean with a dry soft cloth.
- A slightly damp cloth may be used to remove stubborn grime and dirt.
- Never use cleaners such as alcohol, detergents or thinners.
- Avoid placing vinyl objects on top of the unit (vinyl can stick to and discolour the surface).

Electrical interference

- This instrument contains digital circuitry and may cause interference if placed too close to radio or television receivers. If this occurs, move the instrument further away from the affected equipment.

Unpacking

- Please retain the packaging for this product in the unfortunate event that the product or any individual part needs to be returned for service or repair. Please complete the warranty card included with this product and also write your product serial number in the box at the end of this user guide. Returning the completed warranty card does not diminish your statutory rights in anyway.

Drum kit assembly

1. Open the drum frame as illustrated.

*note: for left handed assembly, open the frame legs backwards, so the snare arm is to the right hand side.

2. Once your frame is in position, slightly tighten the frame bolts with your supplied drum key, to reduce movement.

3. Place cymbal poles/Hi-Hat stand and L shape drum arms on the drum frame as illustrated.

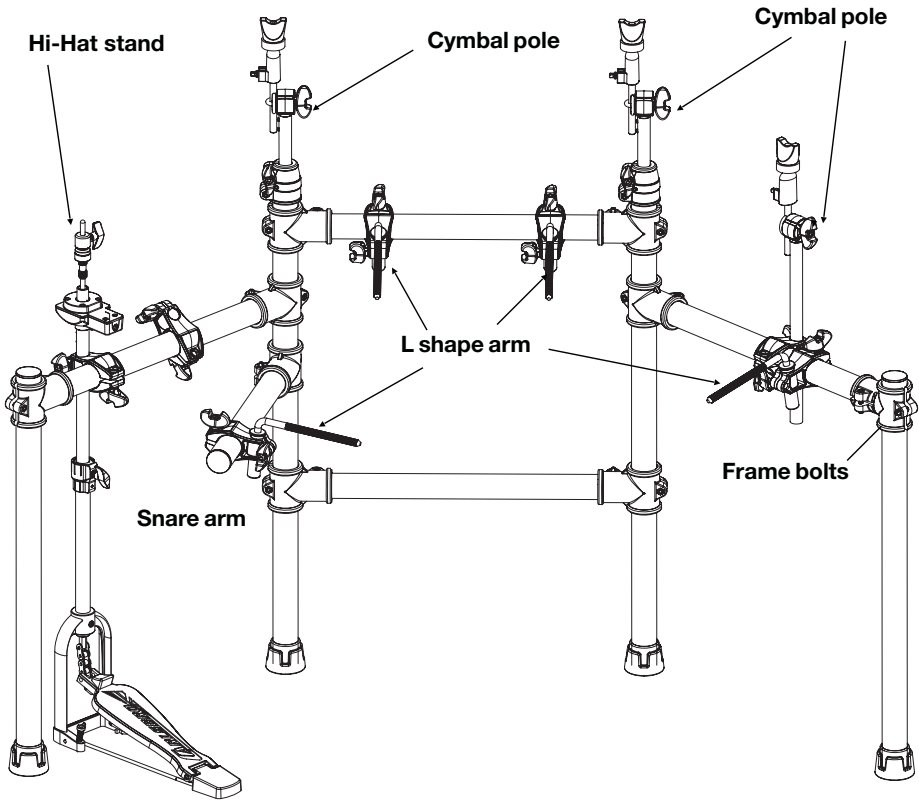

4. Fix the mesh drum pads to the L arms. The snare pad is a larger 10" pad.

5. Place the cymbals on top of the cymbal poles and fasten with the cymbal nuts and felt washer above the cymbal. Do not over tighten, the cymbal should have slight movement and not be rigid.

*note: The Hi-Hat Cymbal pad is different to the Crash and Ride cymbal pads, please pay close attention to the labels on the underside of the cymbal pads.

6. Place the sound module in the remaining frame bracket either side of the Hi-Hat cymbal.

*note: It is ideal for younger drummers to have the module to the front of the frame so that the Hi-Hat is closer to reach. For adults the Hi-Hat and Module position can be reversed to give a much larger playing area.

7. Place the bass tower on the floor to your required position, usually under TOM2 position.

8. Adjust the Hi-Hat stand floor spikes, so the Hi-Hat stand grip to your carpet or rug to reduce movement.

Hi-hat assembly

1. Unscrew the round and crescent metal parts in the Hi-hat support head.

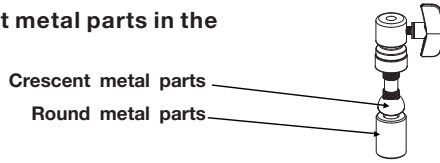

2. Rotate the crescent and round metal parts after stepping on the support head through the positioning hole.

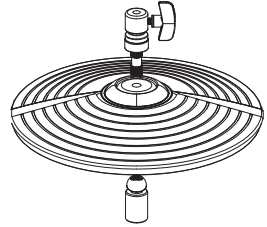

Hi-hat stand assembly

1. Place hi-hat stand base directly beneath the frame mounting point.
2. Thread the metal rod through the frame mounting point and screw into the hi-hat base rod, turning clockwise and fastening tightly.
3. Pass the hi-hat top post through the mounting point and lower the post into the hi-hat base.
4. Set to your desired height, then lock into place with the wing nut on the hi-hat base and the wing nut on the frame mounting point.

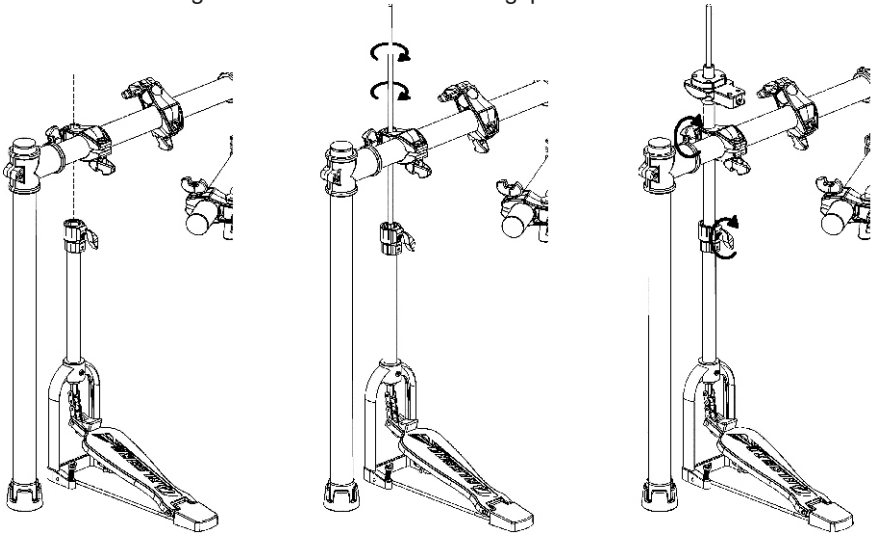

Bass drum assembly

1. The bass drum tower stand is made from 3 parts. Connect the larger plates together using the central connecting bracket found in the bass pad box. The bracket is held in place with 2 drum bolts, fit and tighten these with your supplied drum tool.

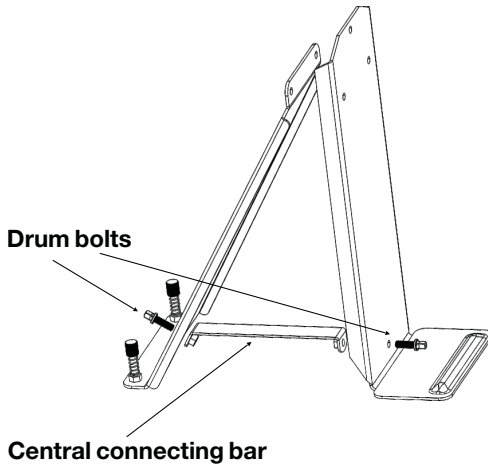

2. Attach the bass pad to the tower stand with the 3 bolts found on the back of the bass pad. These bolts thread through the 3 holes at the top of the tower stand and then fasten into the holes on the back of the bass pad. Tighten these bolts with your supplied drum tool.

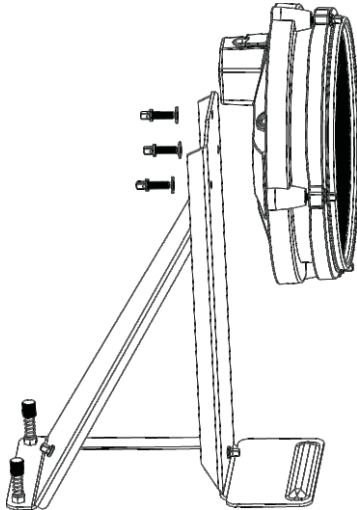

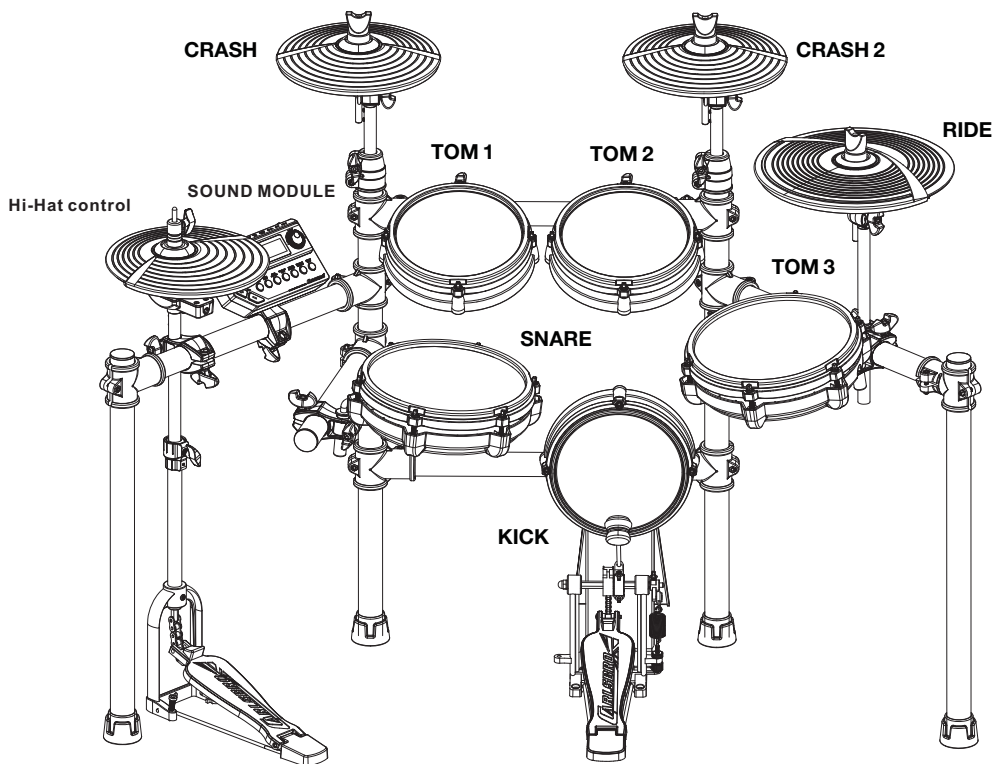

Connecting the drum pads

Before connecting the drum cables, make sure that the power switch is set to the OFF position.

Connect the wiring loom main plug to the drum signal input port on the underside of the module. Fasten tightly with the 2 locating screws on the plug (these will screw in around 4 full turns).

Follow the labels on the end of each cable to match the diagram above, using the stickers on the individual pads and parts for further reference.

Cable 'HH CTRL' (blue) plugs into the Hi-Hat control.

Cable 'Hi-Hat' (white) plugs into the Hi-Hat cymbal.

Cable 'Kick' (grey) plugs into the Kick pedal.

Cable 'Snare' (yellow) plugs into the mesh snare pad with rubber rim.

Cable 'Tom1' (orange) plugs into the the 1st mesh Tom pad.

Cable 'Tom2' (purple) plugs into the 2nd mesh Tom pad.

Cable 'Tom3' (black) plugs into the 3rd mesh Tom pad.

Cable 'Crash' (red) plugs into the crash cymbal pad position.

Cable 'Ride' (green) plugs into the ride cymbal pad position.

Separately packaged Cable 'CRASH2' (black) plugs into the CRASH 2 cymbal pad and the EXT CYMBAL socket on the rear of the sound module.

Positioning your pads

Once your drum set is assembled, you can further adjust the positioning of the frame and pads to suit you. The drum set should be comfortable and all pads should be easy to reach without over stretching.

1. The horizontal frame bars and snare arm can be adjusted up and down to suit drummers of different heights. Loosen the outside bolt on both ends, and slowly move the bar to your desired height, tighten the bolts to secure the position.
2. The frame width can be adjusted by turning the outer legs inwards or outwards allowing the Hi-Hat cymbal, sound module and Tom3 to be positioned closer or further away as needed.
3. The Mesh pads can be moved up/down, left/right, forwards/backwards and also be tilted upwards and downwards. It is ideal to position the Tom pads in such a way to reduce the risk of accidentally striking the pad rim.
4. The cymbals can move up/down and also be tilted, it is important that the cymbals are hit on the rubber playing surface and not the plastic part to reduce noise and possible damage.
5. The Sound module and Hi-Hat cymbal can reverse positions to allow for a wider or narrower playing area. Place the Hi-Hat in the inner holder for a closer set up, or in the outer holder for a larger set up.

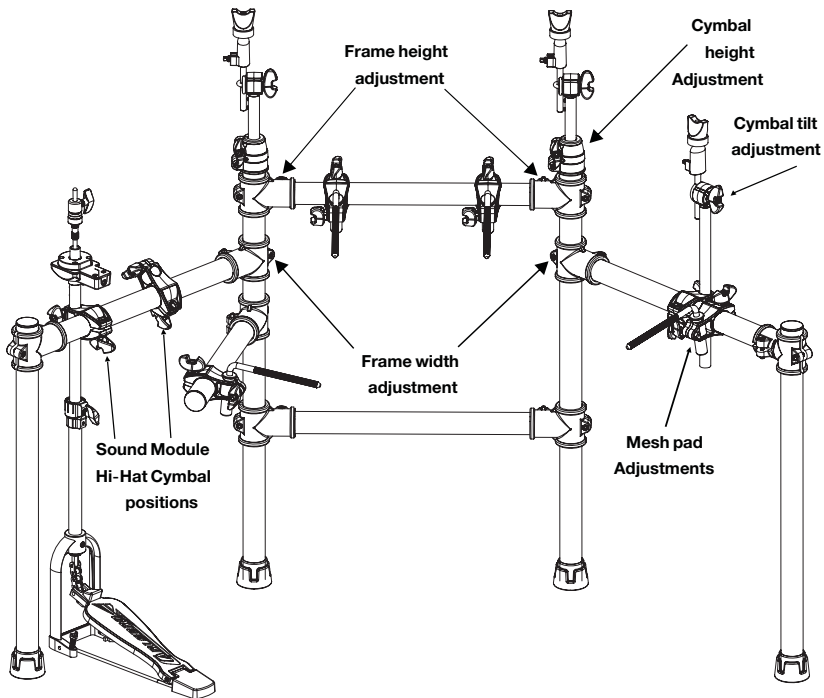

Playing the pads

Similar to an acoustic drum set, this digital drum set responds to various playing techniques, dynamics and velocity. With some voices changing tone depending on the strength of the strike.

1. The Mesh snare pad has 2 sensor zones: main pad and pad rim. On selected voices the rim can have 2 velocity specific sounds that create a side stick (soft) and also a rim shot (hard).
2. Crash 1 and Crash 2 cymbal pads have one zone and also a CHOKE sensor, hit the cymbal and then pinch the central part of the rim to choke (stop) the sound.

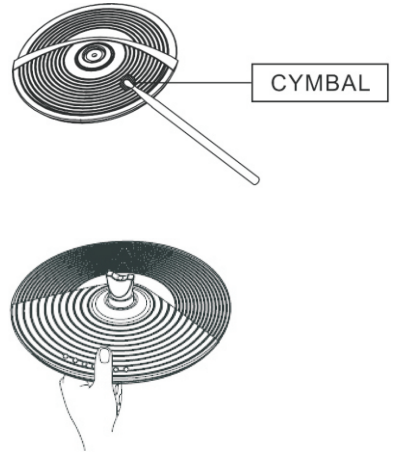
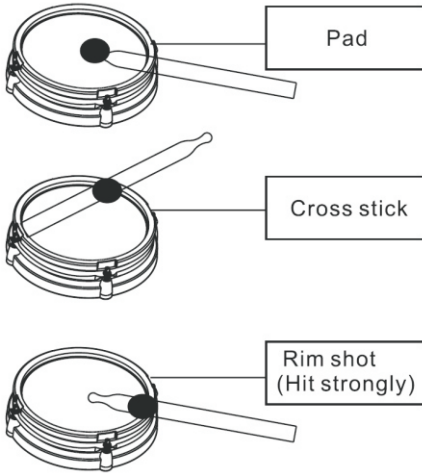

3. The Tom pads have 2 sensor zones: main pad and pad rim.
4. The Ride cymbal has 2 sensor zones: cymbal rim on the edge of the pad and cymbal bell towards the centre of the pad. The Ride cymbal also features the CHOKE function.
5. The Hi-Hat cymbal pad has a single zone sensor. The different sounds of the hi-hat are controlled by the Hi-Hat control pedal.

Hi-Hat control

The Hi-Hat sound changes depending on the action and position of the foot pedal:

1. Strike the Hi-Hat cymbal pad without pressing on the pedal for an OPEN Hi-Hat sound
2. Strike the Hi-Hat cymbal pad with the pedal pressed almost fully down for a HALF OPEN Hi-Hat sound.
3. Strike the Hi-Hat cymbal pad with the pedal fully pressed down for a CLOSED Hi-Hat sound
4. Push the Hi-Hat pedal fully down without striking the Hi-Hat cymbal to create the PEDAL Hi-Hat sound.

Note: When installing the hi-hat cymbal, leave a distance of 5-10mm between the round metal part and the plastic sliding part, depending on how much travel you prefer your hi hat to have.

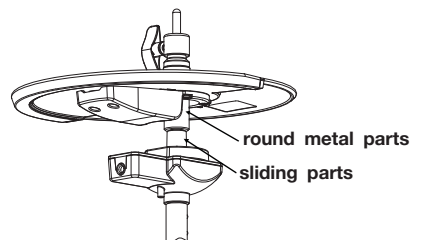

Commander 25 Sound module

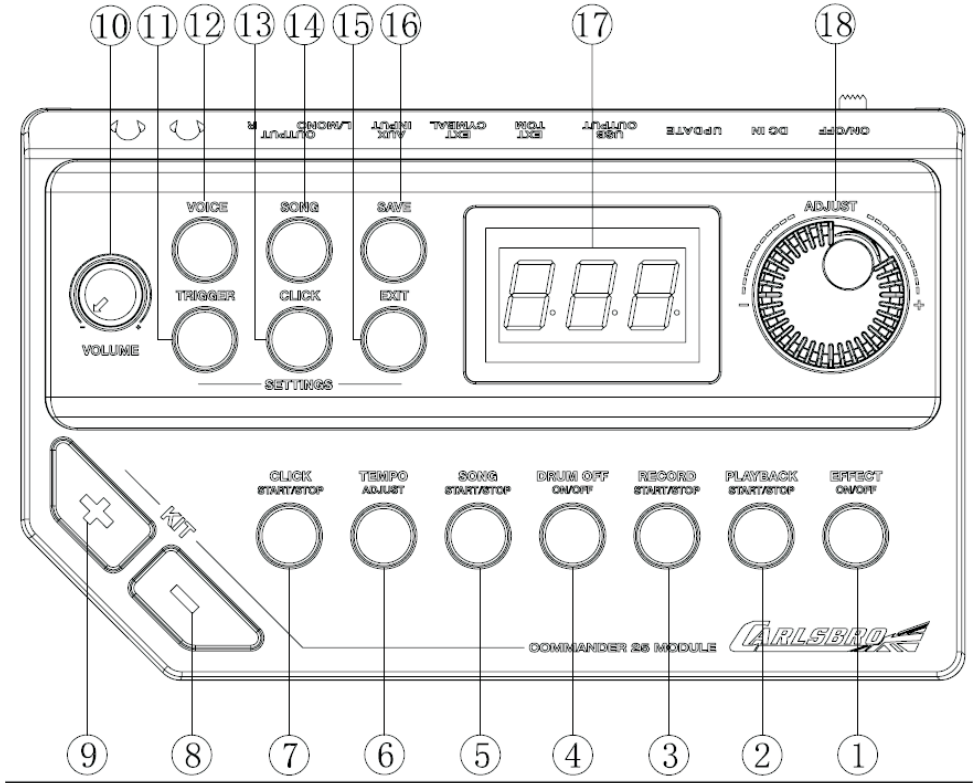

No.	Name	Description
①	EFFECT ON/OFF	When illuminated, the Reverb effect is on.
②	PLAYBACK START/STOP	Press this button once to select the file you wish to listen to, press again to play the selected file.
③	RECORD START/STOP	Press this button once to select which recording file to overwrite. Press again to start the recording. A third press will stop your recording.
④	DRUM ON/OFF	When illuminated, the drum backing track will be removed from the songs.
⑤	SONG START/STOP	Press this button once to start playing a demo song. Press again to stop the demo song
⑥	TEMPO	Quick tempo adjustment for songs and metronome (click)
⑦	CLICK START/STOP	Press this button once to start the metronome, press again to stop the metronome
⑧	KIT-	Change drum kit down
⑨	KIT+	Change drum kit up

⑩	VOLUME	Main Output and Headphone master volume adjustment
⑪	TRIGGER	Enter into Trigger parameter settings
⑫	VOICE	Enter into Voice, User drum kit builder settings
⑬	CLICK	Enter into metronome settings
⑭	SONG	Enter into demo song settings
⑮	EXIT	Exit the current operation and return to kit selection
⑯	SAVE	Save current adjustments to settings
⑰	SCREEN	LED Screen
⑱	ADJUST	Adjustment wheel to adjust parameters

Rear panel

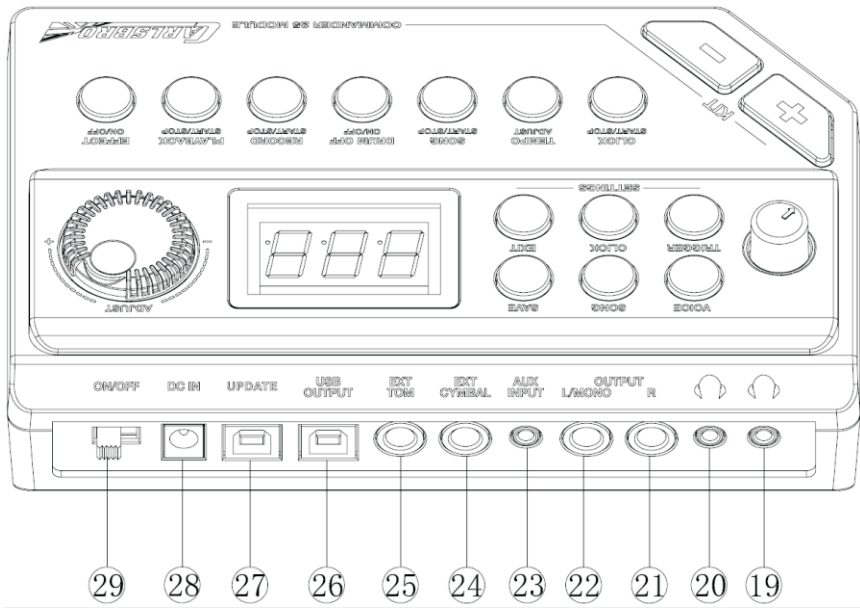

No.	Name	Description
⑱ ⑳	HEADPHONE	2x Stereo headphone output (stereo socket)
㉑	R OUTPUT	Right channel of main stereo audio output (mono socket)
㉒	L(MONO) OUTPUT	Left channel of main stereo output (mono socket)

②3	AUX IN	For connecting an audio device (computer/phone/mp3 player) for music and audio playback.
②4	EXT CYMBAL	Connect to CRASH 2 cymbal pad (cable included)
②5	EXT TOM	Connect to TOM4 extension pack (sold separately)
②6	USB OUTPUT	Connect to computer for MIDI and Audio data transfer
②7	UPDATE	Connect to computer for software upgrades and updates
②8	DC IN	Power adaptor port: 12V 1A
②9	ON/OFF	Power switch

Bottom panel

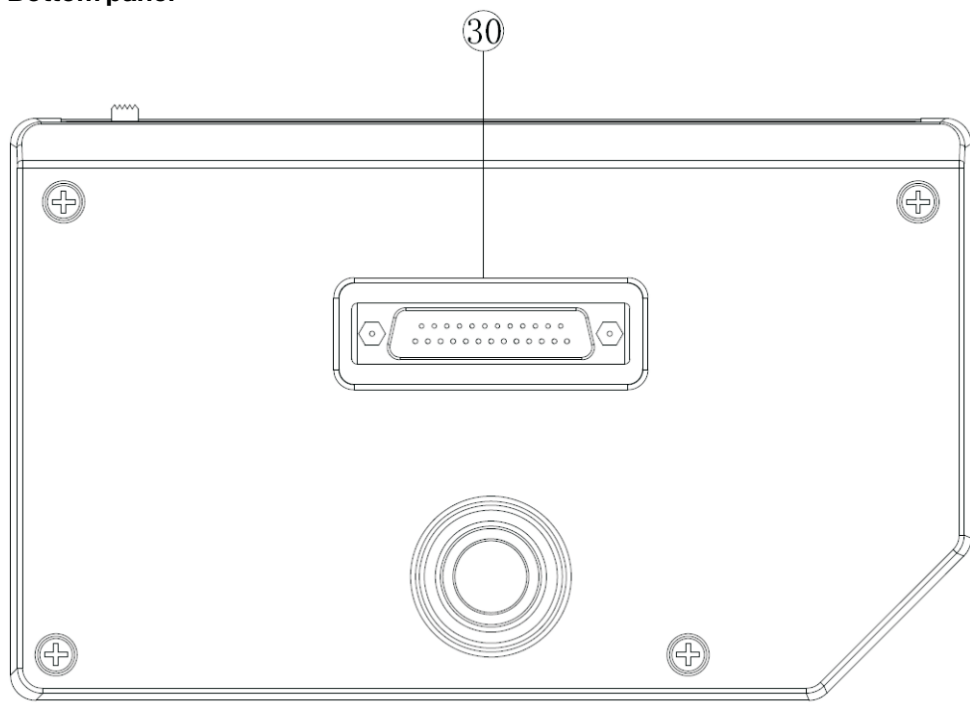

No.	Name	Description
③0	TRIGGER INPUT	Drum signal input port

Connect to mains power

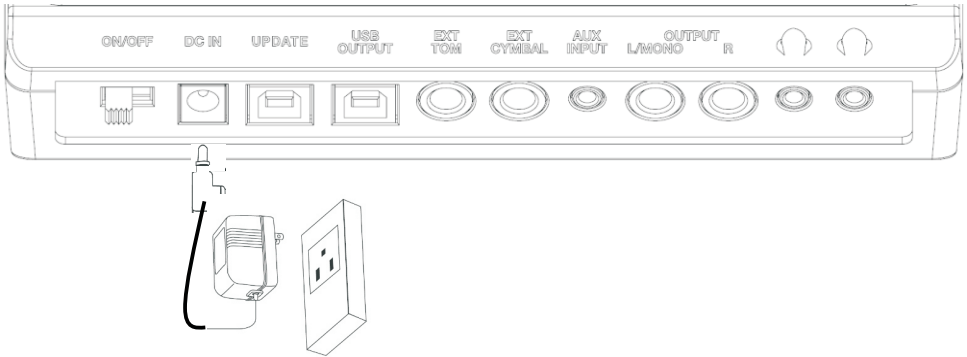

1. Check your AC Adaptor is correct for your countries mains voltage and socket type.
2. Make sure the drum pads, cymbals and pedals are connected correctly.
3. Turn the VOLUME control to minimum.
4. Slide the power switch on the rear panel to the ON position.

Connect to headphones

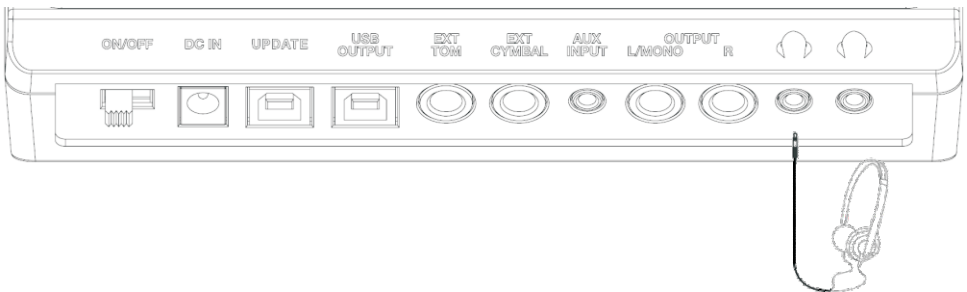

Connect your headphones to one of the two 3.5mm (1/8" stereo) headphone sockets, both sockets can be used simultaneously to hear the sound from the module. The headphone volume is controlled by the VOLUME control.

Connect to amplifier or sound system

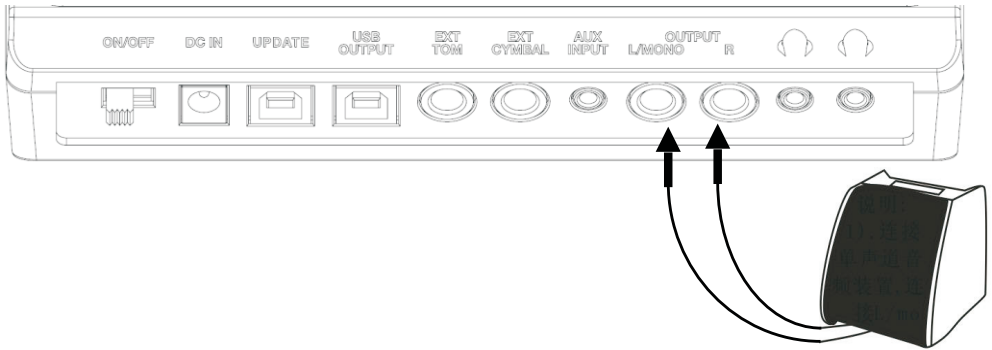

1. Make sure the volume on the sound module and audio system or amplifier are turned down.
2. Connect two mono 6.35mm (1/4") instrument cables to the Left and Right output sockets.
3. Connect the opposite ends of these cables to your audio system or amplifier inputs.
4. If your amplifier or sound system only has one input, you can use one mono 6.35mm(1/4") instrument cable from the L/MONO socket, however you will not get the full effect and quality of the drums.
5. Volume is controlled by the **VOLUME** control on the sound module and also the volume control for your system or amplifier.
6. For best quality and ease, turn the module volume to full and adjust your amplifier volume to your preference.

***note:** It is advised to use an electronic drum amplifier to get the best possible sound. The CSD45M has been designed to work perfectly with the Carlsbro EDA series of drum amplifiers. Contact your Local Carlsbro retailer or distributor for further information and availability on these products.

Connect to audio playback device

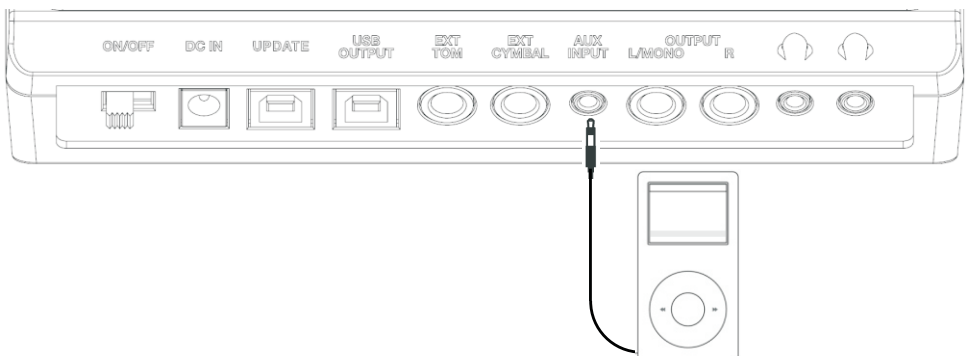

Connect the output of your audio device to the **AUX INPUT** 3.5mm(1/8") stereo connector. The volume should be adjusted on the audio device so the input signal can be mixed with the volume of the drums.

Connect to computer for MIDI and audio data transfer

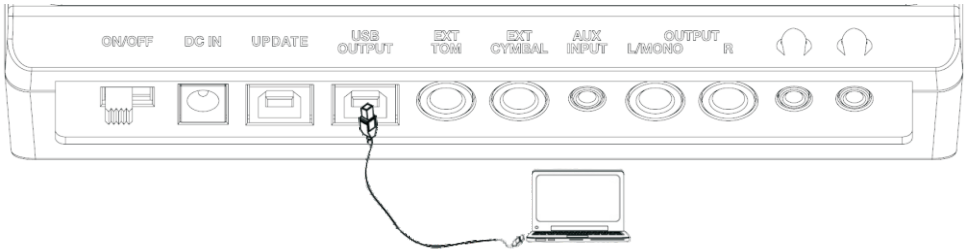

1. Make sure the module is switched off
2. Connect the USB output to your computer with a USB A to USB B cable (not included)
3. Load your desired music software and switch the module on.
4. Your software should automatically prompt you to use device **USB AUDIO**.
5. The sound module can be used as a MIDI input device or an Audio input device, you can select this in your computer software preference settings.
6. Reference **MIDI SETTINGS** later in this guide for further information.

Connect to PC for software update

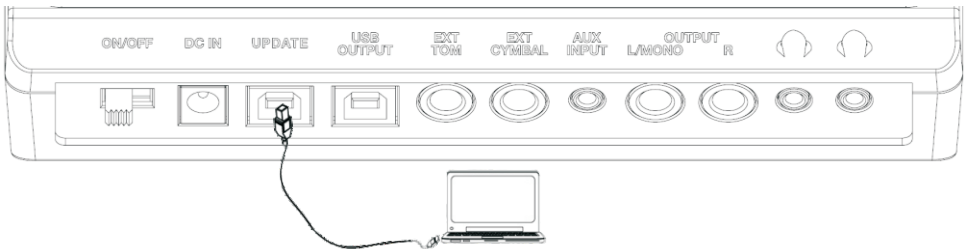

1. Make sure the module is switched off
2. Connect the UPDATE socket to your PC with a USB A to USB B cable (not included)
3. Switch the sound module on.
4. Press and hold the **SAVE** button for 5 seconds, the module buttons will all light up and the module screen will go blank.
5. Your computer will now identify the sound module as a device drive.



6. Download the software update from carlsbro.com/support
7. Update files are identified as `?5M_B_35M_T***.bin` (T** = software version number).
8. Copy the .bin file and paste it to the device drive folder.
*Do not rename or alter this file in anyway.
9. The update will begin.
10. Do not turn off the Sound module or power supply during the update process.
11. If the update is successful, the module will automatically return to its normal state and the device will automatically unmount from the computer.
12. You can now remove the USB cable.
13. If for any reason the module does not return to its normal state, press the **EXIT** button to return to the module home screen.

Basic operation

Selecting a drum kit

The Commander 25 has 22 preset drum kits: 001-022 and 10 user defined drum kits: U01-U10. Press the KIT- or KIT+ buttons to quickly change drum kit, the LED display shows the currently selected drum kit. You can also use the Adjust wheel to quickly cycle through kits.



Playing songs

1. Press the SONG START/STOP button to start the DEMO SONG, press the button again to stop the song.
2. The screen displays the song number you are currently listening to.
3. Use the adjust wheel to scroll through the songs and the SONG START/STOP button to start and stop.

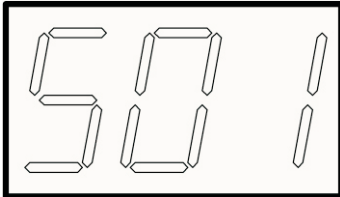

Adjusting songs

Press the SONG button to enter the SONG settings. Here you can adjust the volume of the song A?? and the volume of the drums in the song d??.

1. Press the SONG button once to change the volume of the song with the adjustment wheel a??.
2. Press the SONG button again to select the volume of the drum track with the adjustment wheel d??.
3. Once you are happy with your levels press the save button TWICE to store these settings.

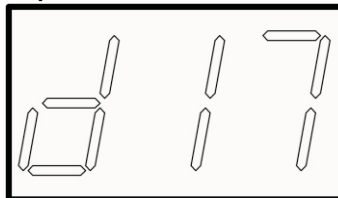
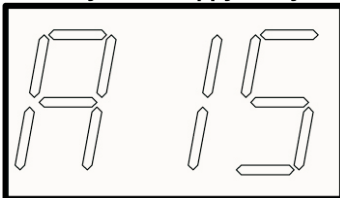

Removing the drum backing from songs (DRUM OFF)

The Commander 25 allows you to quickly remove the drum sounds from the built in songs, to allow you to play along. To do so, press the DRUM OFF button. When this button is lit, the drums will be removed from the backing track.

Adjust the tempo of song tracks and metronome

Press the TEMPO ADJUST button, the screen will show the current BPM. Use the adjustment wheel to quickly adjust the speed of the song and click to your desired BPM.

Using the metronome

Press the **CLICK START/STOP** button, The metronome will start, you will hear a click and also see the **CLICK START/STOP** button flash to indicate the timing. A red light indicates the first beat of the bar and green lights show the following beats.

Press the **CLICK settings** button to scroll through the metronome settings:

1. The screen will show **L??** Use the adjustment wheel here to select the volume of the metronome 0-32.
2. Press the **CLICK** button again and the screen will show **?-?**. Use the adjustment wheel to now select the time signature of the metronome.
1/2, 2/2, 3/2, 4/2, 5/2, 6/2, 7/2, 8/2, 9/2, 1/4, 2/4, 3/4, 4/4, 5/4, 6/4, 7/4, 8/4, 9/4, 1/8, 2/8, 3/8, 4/8, 5/8, 6/8, 7/8, 8/8, 9/8
3. Press the **CLICK** button a third time and the screen will show **u0?**. Use the adjustment wheel to select the metronome voice u01 (electronic metronome 1), u02 (traditional metronome), u03 (Electronic metronome 2), u04 (counting voice).

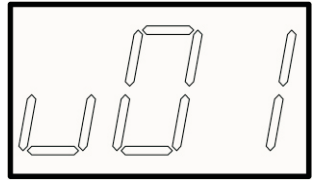
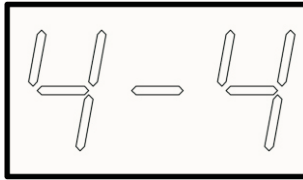
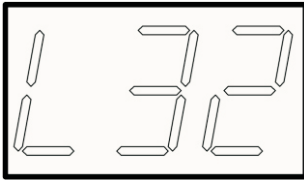

Recording

The Commander 25 has a built in recording function, to allow you to quickly record and save your drum beats and musical ideas. The built in recorder allows you to save 3 separate recordings

1. Press the **RECORD START/STOP** button, the screen will flash **rc?**
2. Use the Adjustment wheel to select which recording slot to record to: rc1, rc2, rc3
3. Press the **RECORD START/STOP** button to confirm your selection and start your recording. The actual recording will start when you strike the first pad, so there is no need to rush.
4. When you have finished your performance, Press the **RECORD START/STOP** button to stop the recording.
5. The recording is now automatically saved to your selected recording slot rc1, rc2, rc3.
6. The screen will flash again to allow you to rerecord over your current recording or use the adjustment wheel to select another recording slot to record to.

Listening to your recordings

1. Press the **PLAYBACK** button to enter the playback menu, the screen will flash with **rc?**
2. Use the Adjustment wheel to select which recording slot to listen to: rc1, rc2, rc3
3. Press **PLAYBACK** button to confirm your selection and your recording will now begin to play.
4. Press **PLAYBACK** button at anytime to stop the playback and return to the playback menu.
5. When playback of your recording finishes you will automatically return to the playback menu.

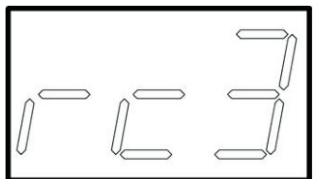
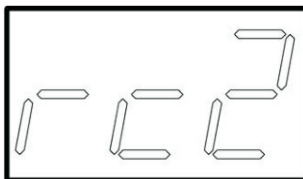
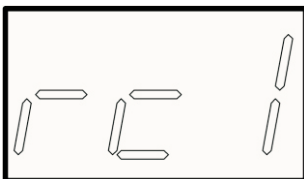

Building your own drum kits

The Commander 25 has 10 User defined drum kit slots, you can choose the sounds that you hear on each and every pad, to create your own personalised selection of drum kits. Pick from any of the 320 drum and percussion sounds, select which pad to add the sound to. Adjust the volume, tuning, stereo balance, reverb amount and also MIDI note of every pad and zone.

Basic adjustment

1. Press the VOICE button to enter into the drum kit designer mode. The VOICE button will remain lit whilst in this menu. The first screen shows you the voice number for the last pad that was played 001-320.
2. Strike a pad you wish to begin with. The screen will show you the voice number for this pad.
3. Use the adjustment wheel to change the voice of this pad. A full list of voices and corresponding numbers can be found towards the end of this manual.
4. Strike the pad again to hear the new sound.
5. Once you have found the sound you like you can now save your adjustment to one of the 10 User kits.
6. Press the SAVE button and the screen will flash U01, use the adjustment wheel to select which kit you would like to save to U01-U10.
7. When you have selected the kit you wish to save to, press the SAVE button again to confirm your selection and permanently save your kit.

*note: Be careful not to strike any other pads or pedals whilst making your adjustments, as the parameters will then move on to that pad.

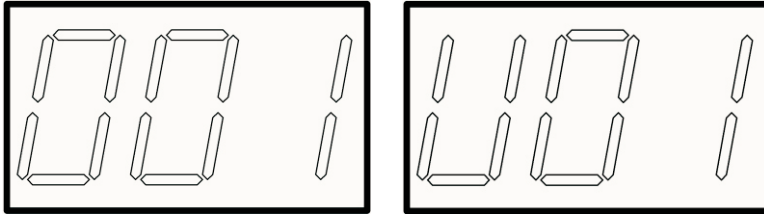

Advanced drum kit building

1. Whilst in the VOICE menu press the VOICE button again to adjust the voice volume for this pad L00-L32

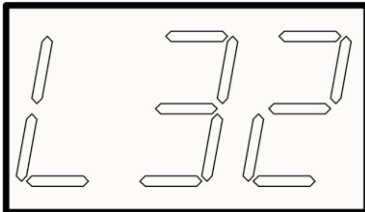

2. Press the VOICE button again to adjust the pitch tuning of the voice for this pad T-5-T+5. 0 has no tuning change to the voice, increase the number to make the pitch higher, reduce the number to make the pitch lower.

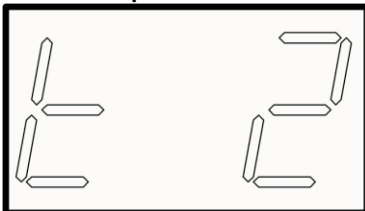

3. Press the **VOICE** button again to adjust the stereo panning of the voice P-8-P+8. 0 is the central position, negative values shift the voice to the left side of the stereo field, Positive numbers shift the voice to the right of the stereo field.

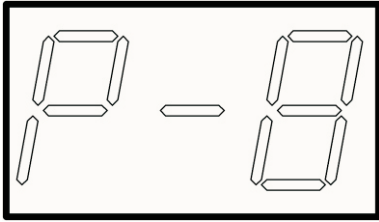

4. Press the **VOICE** button again to adjust the reverb amount of the voice r00-r32. 0 is no reverb applied. The higher the number the more reverb effect that is added to the voice.

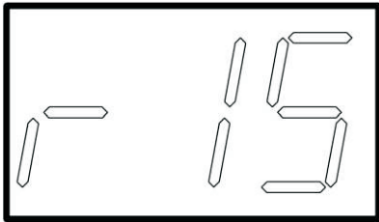

5. Press the **VOICE** button again to adjust the MIDI Note for this pad or zone. The preset values are set to work with most controller and tuition software, so this value should not need to be adjusted, Unless you are using specific software or hardware applications that may require different notes to trigger different sounds.

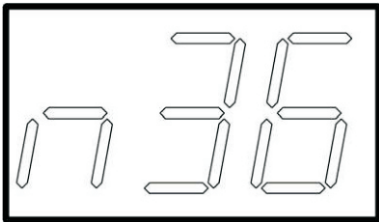

6. When you are happy with your adjustments, remember to save your creations to a user kit of your choice. It is advised to save your settings often whilst making adjustments, Just press the **SAVE** button, select the user kit number you wish to store your kit to, using the adjustment wheel, and press **SAVE** again to confirm your selection.

Trigger settings

The Commander 25 has adjustable settings for each pad trigger. The adjustments made here will affect how each individual pad reacts. These settings are navigated similarly to the VOICE settings above.

Pad Curve

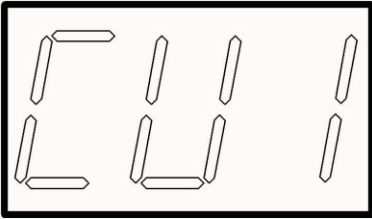

Press the TRIGGER button to enter trigger settings, the screen will first display pad curve CU? Pad curve adjusts the ratio between strike velocity (the strength of your strike) and voice volume. Strike the pad you wish to adjust, use adjustment wheel to select curve, press SAVE twice to store.

Curve 1. (Boosted) Lighter strikes will have increased volume.

Curve 2. (Straight) Lighter strikes have low volume, heavy strikes have loud volume.

Curve 3. (Natural) Emulates acoustic drum feel, volume increases smoothly with your velocity.

Curve 4. (Boosted natural) Curve 3 with a slight low velocity volume boost.

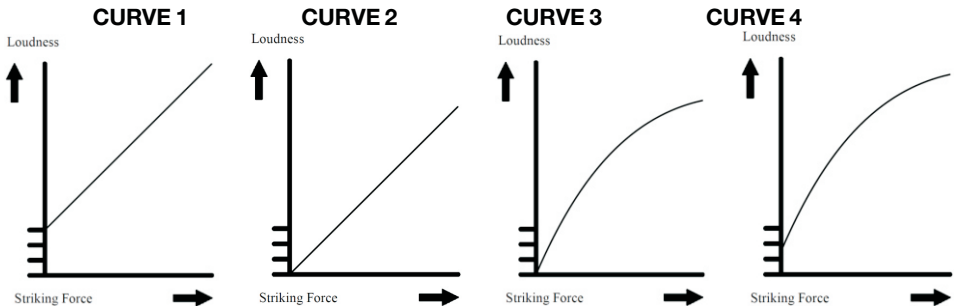

Pad threshold

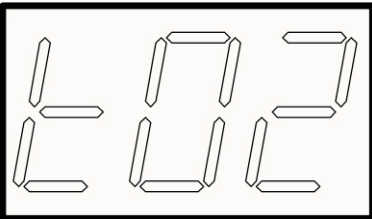

Press the TRIGGER button a second time to enter the threshold adjustment t??.

Threshold sets the level at which a strike can be heard. This value is important to reduce unwanted triggering from vibration from other pads and through the frame. The higher the threshold value the higher the velocity necessary to trigger the pad.

Strike the pad you wish to adjust, use the adjustment wheel to change the value and press SAVE TWICE to store your settings.

*note: If you can hear another pad triggering which you have not played, locate that pad, and increase the threshold value until the unwanted triggering disappears.

Pad sensitivity

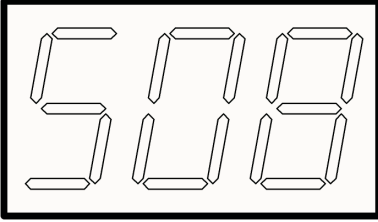

Press the TRIGGER button a third time to enter the sensitivity adjustment S??.

Higher sensitivity value allows the pad to produce a louder volume when played softer.

Lower sensitivity value allows the pad to produce a quieter volume when played harder.

Strike the pad you wish to adjust, use adjustment wheel to change value and press **SAVE TWICE** to store.

Pad crosstalk

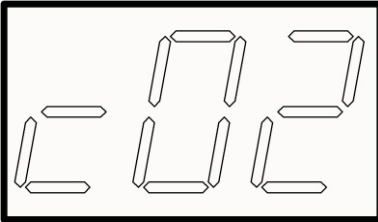

Press the TRIGGER button a fourth time to enter the crosstalk adjustment c??.

Similar to Threshold, the crosstalk adjustment works for pads that are located closely together, where close proximity can cause an adjacent pad to mis-trigger. This can be eliminated by setting a high crosstalk value to the mis-triggering pad.

*note: In most cases this value should not need to change from the factory preset. However if you do discover a crosstalk issue, the value should only be adjust 1-3 points, as small adjustments can make a large difference. You can also consider adjusting the location of the offending pads to create a larger gap between the pads.

Hi-Hat control type selection

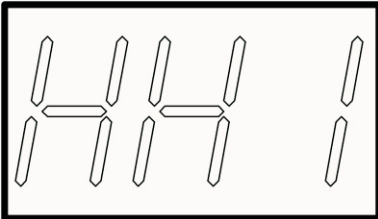

Press the TRIGGER button a fifth time to enter the HI-HAT control type selection HH?.

The CSD35M allows you to upgrade your Hi-Hat control to a hardware Hi-Hat stand (available separately).

HH1 - Included Hi-Hat control pedal.

HH2 - Open/Close hardware stand and stand mount HH CTRL.

Bass drum control type selection

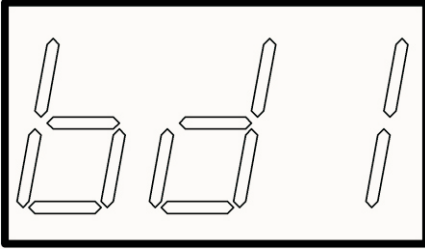

Press the TRIGGER button a sixth time to enter the bass drum control type selection bd?.

The Commander 25 allows you to change your Bass drum pad and beater to a noise reducing switch control pedal (available separately).

bd1 - Setting for kick switch control pedal.

bd2 - Setting for hardware 2?rubber floor bass pad.

bd3 - Setting for Included 8?mesh bass drum pad.

Local control

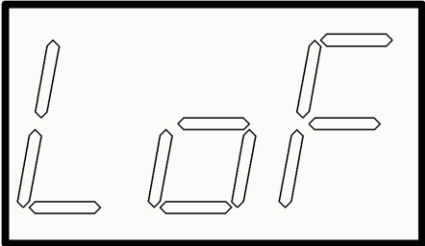

Press the TRIGGER button a seventh time to adjust the local MIDI control setting, used to control the connection between the trigger and the controller.

Lon: Default, the pads are connected with the module to send MIDI data to your MIDI source.

LoF: The sounds on the module are controlled by MIDI data from a MIDI source, and not by the pads.

Factory reset

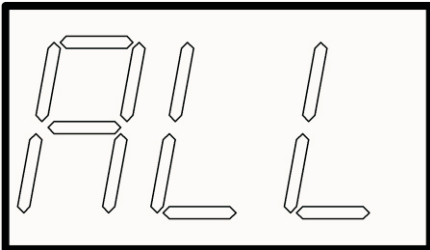

Press and hold the SAVE and EXIT buttons together for 5 seconds.

The screen will display ALL.

Press the SAVE button to fully reset the module to its factory status.

OR

Press the KIT +/- buttons to reset an individual USER drum kit.

The Screen will show U01, use the adjustment wheel to select the kit you wish to reset.

Press the SAVE button to reset the selected USER drum kit to its factory status.

Expanding your CSD45M

The CSD45M allows for the following pads and upgrade packs to be added to your drum set:

Carlsbro TOM4 8?dual zone mesh tom pad with accessories: CSDPK-T8MP

Carlsbro upright mesh bass pad and tower stand: CSDPK-MBP

Carlsbro bass drum kick pedal with beater (used with CSDPK-MBP): CSDPK-PDL1

Carlsbro hardware open/close hi-hat with accessories: CSDPK-OCHH2

All above expansion packs include all the required hardware and accessories.

Contact your Local Carlsbro retailer or distributor for further information and availability.

MIDI settings

The Commander 25 is compatible with various MIDI software, hardware and also GM standard.

Connection for MIDI control and recording:

1. Connect the sound module USB output to a computer with a USB A to USB B cable (not included).
2. Software should automatically register the sound module as a USB MIDI input.
3. Select or create a MIDI track.
4. Select a software drum kit or instrument.
5. Set the track input as a USB MIDI device.
6. Play the pads to control your chosen software instrument.

Connection for tutorial software:

1. Connect the sound module USB output to a computer with a USB A to USB B cable (not included).
2. Software should automatically register the sound module as a USB MIDI input.
3. If needed, set the software input device as USB MIDI.
4. Play the pads to control your tutorial software.

If your software is unable to recognise certain pads, you can adjust the output MIDI notes for each pad to correspond with your software:

1. Press the VOICE button until you reach the MIDI note setting, n??
2. Strike the pad you need to adjust.
3. Use the adjustment wheel to select the required MIDI note for your software.
4. Press the SAVE button to save these settings as a USER DRUM KIT U??

CSD35M default MIDI notes

TRIGGER	MIDI NOTE	TRIGGER	MIDI NOTE	TRIGGER	MIDI NOTE
KICK	36	TOM3	43	CRASH	49
SNARE RIM	37	HI-HAT PEDAL	44	TOM1 RIM	50
SANRE	38	TOM2	45	RIDE	51
TOM4 RIM	39	HI-HAT OPEN	46	CRASH2	57
TOM4	41	TOM2 RIM	47	TOM3 RIM	58
HI-HAT CLOSED	42	TOM1	48	RIDE RIM	59

Using the Commander 25 as a MIDI audio source

Connect with a computer via USB. A MIDI interface, keyboard or sequencer device also connected via this computer, can send MIDI data to the Module. The Module will receive a MIDI output signal from the computer, and replay the MIDI data with the sounds from the selected DRUM KIT 001-U10.

*note: Song playback data and metronome notes are not transferred via MIDI.

MIDI USB: USB2.0 interface. Compatible with most computer operating systems such as: Win10, Win7, Vista, Mac OSX, etc.

This device connects and transfers data via MIDI channel 10.

MIDI support and limitations are described in the MIDI list below:

MIDI list

FUNCTION		TRANSMITTED	RECOGNISED	REMARKS
B ASIC CHANNEL	DEFAULT	10 Ch	1-16	
	CHANGED	1-16	1-16	
MODE	DEFAULT	x	x	
	MESSAGES	x	x	
	ALTERED	*****	*****	
NOTE NUMBER :	TRUE VOICE	0-127	0-127	
		*****	0-127	
VELOCITY	NOTE ON	O 9nH,V=1-127	o	
	NOTE OFF	X (9nH,V=0)	o	
AFTER TOUCH	KEY拵 CH拵	x x	x x	
PITCH BEND			x	
CONTROL CHANGE	0	x	o	BANK SELECT
	1	x	o	MODULATION
	5	x	o	PORTAMENTO TIME
	6	x	o	DATA ENTRY
	7	x	o	VOLUME
	10	x	o	PAN
	11	x	o	EXPERSSION
	64	x	o	SUSTAIN PEDAL
65	x	o	PORTAMENTO ON/OFF	

		66	x	○	SOSTENUTO PEDAL
		67	x	○	SOFT PEDAL
		80	x	○	REVERB PROGRAM
		81	x	○	CHORUS PROGRAM
		91	x	○	REVERB LEVEL
		93	x	○	CHORUS LEVEL
		120	x	○	ALL SOUND OFF
		121	x	○	RESET ALL CONTROLLERS CONTROLLERS
		123	x	○	ALL NOTES OFF
TONE			○	○	
CHANGE	TRUE NUMBER	*****		0-127	
SYSTEM EXCLUSIVE				○	
SYSTEM	: SONG POSITION	x		x	
COMMON	: SONG SELECT	x		x	
	: TUNE	x		x	
SYSTEM	: CLOCK ON/OFF	○		x	
REAL TIME	: COMMANDS	○		x	START AND STOP ONLY
AUX	: LOCAL ON/ OFF	x		x	
MESSAGE	: ALL NOTES OFF	x		x	
	: ACTIVE SENSING	○		x	
	: RESET	x		x	

Trouble shooting

Problem	Reason or solution
No sound from headphones	<ol style="list-style-type: none"> 1. Make sure the volume control is set correctly and turn the volume control clockwise to its full position. 2. Check that the headphones are connected to one of the 3.5mm 1/8" headphone sockets without the use of any adaptors. 3. Test the headphones in another device to check that the headphones are working correctly.
No sound from amplifier or sound system	<ol style="list-style-type: none"> 1. Make sure the volume control is set correctly and turn the volume control clockwise to its full position. 2. Check that the cables are connected to the module L and R output sockets and the other end of the cables are connected to your amplifier or sound system inputs. Make sure the cables used are mono instrument cables, not speaker cables or TRS/Stereo cables.
No sound from a drum pad	<ol style="list-style-type: none"> 1. Check that the labelled cable is connected to the correct pad or pedal, reference Connecting Drum Pads. 2. Check that local setting is set to on 'Lon' reference Trigger Settings. 3. Check that the corresponding pad voice volume is not set to 0, 'L00' reference Voice Settings. 4. Test the suspect pad or pedal with a similar pad or pedal cable, [Cymbals], [Mesh pads], [Pedals]. 5. Check the main loom connection on the underside of the sound module. Remove and refit making sure the locating screws are fully tightened this should be 4 full turns.
No sound from Bass Drum	Check bass drum trigger settings selection type (Bd?) matches your bass drum hardware <i>Reference page 18</i>
No sound from Hi-Hat	Check Hi-Hat trigger settings selection type (HH?) matches your Hi-Hat hardware <i>Reference page 17</i>
No sound on metronome	Check that metronome volume is not 0. <i>Reference page 13</i>
No sound on DEMO SONG	Check that song volume is not 0. <i>Reference page 12</i>
There is no signal to MIDI communication devices	<ol style="list-style-type: none"> 1. Check whether the USB cable used is connected to the USB OUTPUT socket and not the UPDATE socket. 2. Verify the computer software communication channel is set to channel 10. 3. Verify the software audio input and also individual MIDI track input is set to a USB MIDI input. 4. Test the USB cable in another device to check for damage.
Module unresponsive	<ol style="list-style-type: none"> 1. Press EXIT button. 2. Switch power off and back on.
Unable to resolve above	<ol style="list-style-type: none"> 1. Perform factory reset. 2. Check for software update. 3. Contact your place of purchase for further assistance.

Sound module specifications

Polyphony: 64

Display: 3-segment numeric LED

Voice: 320 drum and percussion voices + 128 GM music tones

Drum Kits: 22 factory-shipped DRUM KITS + 10 user defined DRUM KITS

Sequencer:

3 Recording slots. Up to 1000 notes

20 Demo songs

Tempo function:

Tempo tones: 4

Tempo range: 30-250BPM

Time signatures: 1/2-9/8

Connection:

Headphone Output: Stereo 3.5mm (1/8" x2)

AUX Input: Stereo 3.5mm (1/8")

Audio Output: Left (MONO) Output, Right Output mono 6.35mm (1/4"

Pad Sensors: (D-SUB 25P)

MIDI IN/OUT Data Interface: USB B

AUDIO Data Interface: USB B

USB Update Interface: USB B

Extension sockets: EXT CYMBAL (Crash2), EXT TOM (Tom4) 6.35mm (1/4" TRS Jack with 3 core cable.

*** The specification is subject to change without prior notice ***

Drum kit list

No.	Name	No.	Name
KIT01	ROCK	KIT17	BRUSH
KIT02	FUNK/POP	KIT18	ELE1
KIT03	JAZZ	KIT19	ELE2
KIT04	LATIN	KIT20	COUNTRY
KIT05	DANCE	KIT21	ORCH
KIT06	POP1	KIT22	PERCUSSION
KIT07	POP2	KIT23	USER01
KIT08	POP3	KIT24	USER02
KIT09	HARD ROCK	KIT25	USER03
KIT10	METAL	KIT26	USER04
KIT11	FUNK1	KIT27	USER05
KIT12	FUNK2	KIT28	USER06
KIT13	HIP-HOP	KIT29	USER07
KIT14	FUSSION	KIT30	USER08
KIT15	BLUES	KIT31	USER09
KIT16	CUBAN	KIT32	USER10

Voice list

	KICK	SNARE	HI-HAT	TOM	CYMBAL	PERCUSSION
1	KICK01	27 SNARE01	72 CLHIHAT01	143 TOMH1	174 CRSH01	223 HLQ
2	KICK02	28 SNARE02	73 CLHIHAT02	144 TOMH2	175 CRSH02	224 SLAP
3	KICK03	29 SNARE03	74 CLHIHAT03	145 TOMH3	176 CRSH03	225 SCRCH1
4	KICK04	30 SNARE04	75 CLHIHAT04	146 TOMH4	177 CRSH04	226 SCRCH2
5	KICK05	31 SNARE05	76 CLHIHAT05	147 TOMH5	178 CRSH05	227 STICK
6	KICK06	32 SNARE06	77 CLHIHAT06	148 TOMH6	179 CRSH06	228 SQCLCK
7	KICK07	33 SNARE07	78 CLHIHAT07	149 TOMH7	180 CRSH07	229 CLICK
8	KICK08	34 SNARE08	79 CLHIHAT08	150 TOMM1	181 CRSH08	230 BELL
9	KICK09	35 SNARE09	80 CLHIHAT09	151 TOMM2	182 CRSH09	231 CLAP1
10	KICK10	36 SNARE10	81 CLHIHAT10	152 TOMM3	183 CRSH10	232 CLAP2
11	KICK11	37 SNARE11	82 CLHIHAT11	153 TOMM4	184 CRSH11	233 CLAP3
12	KICK12	38 SNARE12	83 CLHIHAT12	154 TOMM5	185 CRSH12	234 TAMBRINE
13	KICK13	39 SNARE13	84 CLHIHAT13	155 TOMM6	186 CRSH13	235 COWBELL1
14	KICK14	40 SNARE14	85 CLHIHAT14	156 TOMM7	187 CRSH14	236 COWBELL2
15	KICK15	41 SNARE15	86 CLHIHAT15	157 TOMM8	188 CRSH15	237 COWBELL3
16	KICK16	42 SNARE16	87 CLHIHAT16	158 TOML1	189 CRSH16	238 COWBELL4
17	KICK17	43 SNARE17	88 PDLHHT01	159 TOML2	190 CRSH17	239 ECOWBELL1
18	KICK18	44 SNARE18	89 PDLHHT02	160 TOML3	191 CRSH18	240 ECOWBELL2
19	KICK19	45 SNARE19	90 PDLHHT03	161 TOML4	192 CRSH19	241 VSLAP
20	KICK20	46 SNARE20	91 PDLHHT04	162 TOML5	193 CRSH20	242 HIBONGO
21	KICK21	47 SNARE21	92 PDLHHT05	163 TOML6	194 CRSH21	243 LOBANGO
22	KICK22	48 SNARE22	93 PDLHHT06	164 TOML7	195 CRSH22	244 MUTECONGA1
23	KICK23	49 SNARE23	94 PDLHHT07	165 TOML8	196 CRSH23	245 MUTECONGA2
24	KICK24	50 SNARE24	95 PDLHHT08	166 TOML9	197 CRSH24	246 HICONGA1
25	KICK25	51 SNARE25	96 PDLHHT09	167 TOME1	198 CRSH25	247 HICONGA2
26	KICK26	52 SNARE26	97 PDLHHT10	168 TOME2	199 CRSH26	248 LOCONGA1
		53 SNARE27	98 PDLHHT11	169 TOME3	200 CRSH27	249 LOCONGA2
		54 SNARE28	99 PDLHHT12	170 TOME4	201 CRSH28	250 HTIMBL1
		55 SNRIM1	100 PDLHHT13	171 TOME5	202 RIDE1	251 HTIMBL2
		56 SNRIM2	101 PDLHHT14	172 TOME6	203 RIDE2	252 LTIMBL1
		57 SNRIM3	102 PDLHHT15	173 TOME7	204 RIDE3	253 LTIMBL2
		58 SNRIM4	103 PDLHHT16		205 RIDE4	254 HIAGOGO
		59 SNRIM5	104 OPNHHT01		206 RIDE5	255 LOAGOGO
		60 SNRIM6	105 OPNHHT02		207 RIDE6	256 CABASA
		61 SNRIM7	106 OPNHHT03		208 RIDE7	257 MARACS
		62 SNRIM8	107 OPNHHT04		209 RIDE8	258 WHISTLE_S

	63	ESNR1	108	OPNHHT05			210	RDBELL1	259	WHISTLE_L
	64	ESNR2	109	OPNHHT06			211	RDBELL2	260	SGUIRO
	65	ESNR3	110	OPNHHT07			212	RDBELL3	261	GUIRO_S
	66	ESNR4	111	OPNHHT08			213	RDBELL4	262	GUIRO_L
	67	ESNR5	112	OPNHHT09			214	RDBELL5	263	CLAVES
	68	ESNR6	113	OPNHHT10			215	RDBELL6	264	WBLK_H
	69	ESNR7	114	OPNHHT11			216	RDBELL7	265	WBLK_L
	70	ESNR8	115	OPNHHT12			217	ELCRASH1	266	CUICA_M
	71	ESNR9	116	OPNHHT13			218	ELCRASH2	267	CUICA_O1
			117	OPNHHT14			219	ELCRASH3	268	CUICA_O2
			118	OPNHHT15			220	ELCRASH4	269	MTRIANGLE
			119	OPNHHT16			221	ELCRASH5	270	OTRIANGLE
			120	HOPNHHT01			222	ELCRASH6	271	SHAKER1
			121	HOPNHHT02					272	SHAKER2
			122	HOPNHHT03					273	JNGLBL
			123	HOPNHHT04					274	BLTREE
			124	HOPNHHT05					275	CSTNTS1
			125	HOPNHHT06					276	CSTNTS2
			126	HOPNHHT07					277	SURDO_M
			127	HOPNHHT08					278	SURDO_O
			128	HOPNHHT09					279	TLKNDML
			129	LSHHT1					280	TLKNDMH
			130	LSHHT2					281	TABLA1
			131	LSHHT3					282	TABLA2
			132	LSHHT4					283	SNAP
			133	LSHHT5					284	DJMB1
			134	LSHHT6					285	DJMB2
			135	LSHHT7					286	DJMB3
			136	ELCHHT1					287	CAJON1
			137	ELCHHT2					288	CAJON2
			138	ELCHHT3					289	CAJON3
			139	ELCHHT4					290	TMPNI1
			140	ELCHHT5					291	TMPNI2
			141	ELCHHT6					292	GONG_L
			142	ELCHHT7					293	ELCLKH
									294	ELCLKL
									295	TAIKO
									296	BELL

35 - B1	Acoustic Bass Drum	1	KICK01
36 - C2	Bass Drum 1	6	KICK06
37 - C#2	Side Stick	55	SNRIM1
38 - D2	Acoustic Snare	49	SNARE23
39 - D#2	Hand Clap	231	CLAP1
40 - E2	Electric Snare	28	SNARE02
41 - F2	Low Floor Tom	160	TOML3
42 - F#2	Closed Hi Hat	72	CLHIHAT01
43 - G2	High Floor Tom	160	TOML3
44 - G#2	Pedal Hi-Hat	88	PDLHHT01
45 - A2	Low Tom	151	TOMM2
46 - A#2	Open Hi-Hat	104	OPNHHT01
47 - B2	Low-Mid Tom	144	TOMH2
48 - C3	Hi-Mid Tom	144	TOMH2
49 - C#3	Crash Cymbal 1	184	CRSH11
50 - D3	High Tom	144	TOMH2
51 - D#3	Ride Cymbal 1	206	RIDE5
52 - E3	Chinese Cymbal	193	CRSH20
53 - F3	Ride Bell	213	RDBELL4
54 - F#3	Tambourine	234	TAMBRINE
55 - G3	Splash Cymbal	191	CRSH18
56 - G#3	Cowbell	235	COWBELL1
57 - A3	Crash Cymbal 2	185	CRASH12
58 - A#3	Vibraslap	241	VSLP1
59 - B3	Ride Cymbal 2	209	RIDE8
60 - C4	Hi Bongo	242	HIBONGO
61 - C#4	Low Bongo	243	LOBANGO
62 - D4	Mute Hi Conga	244	MUTECONGA1
63 - D#4	Open Hi Conga	246	HICONGA1
64 - E4	Low Conga	248	LOCONGA1
65 - F4	High Timbale	250	HTIMBL1
66 - F#4	Low Timbale	252	LTIMBL1
67 - G4	High Agogo	254	HIAGOGO
68 - G#4	Low Agogo	255	LOAGOGO

69 - A4	Cabasa	256	CABASA
70 - A#4	Maracas	257	MARACS
71 - B4	Short Whistle	258	WHISTLE_S
72 - C5	Long Whistle	259	WHISTLE_L
73 - C#5	Short Guiro	260	SGUIRO
74 - D5	Long Guiro	262	GUIRO_L
75 - D#5	Claves	263	CLAVES
76 - E5	Hi Wood Block	264	WBLK_H
77 - F5	Low Wood Block	265	WBLK_L
78 - F#5	Mute Cuica	266	CUICA_M
79 - G5	Open Cuica	267	CUICA_O1
80 - G#5	Mute Triangle	269	MTRIANGLE
81 - A5	Open Triangle	270	OTRIANGLE
82 - A#5	Shaker	271	SHAKER1
83 - B5	Jingle Bell	273	JNGLBL
84 - C6	Bell Tree	274	BLTREE
85 - C#6	Castanets	275	CSTNTS1
86 - D6	Mute Surdo	277	SURDO_M
87 - D#6	Open Surdo	278	SURDO_O

Demo song list

No.	Name	Meter	Tempo
DEMO 01	POP ROCK	4/4	90
DEMO 02	FUNK	4/4	110
DEMO 03	SHUFFLE	4/4	117
DEMO 04	SHUFFLE	4/4	128
DEMO 05	ROCKBLUES	4/4	105
DEMO 06	ROCK	2/4	120
DEMO 07	ROCK	4/4	138
DEMO 08	DANCE	2/4	140
DEMO 09	POP	4/4	123
DEMO 10	POP	4/4	100
DEMO 11	POP	4/4	82
DEMO 12	POP	4/4	159
DEMO 13	COUNTRY	4/4	120
DEMO 14	COUNTRY	4/4	108
DEMO 15	SWING	4/4	140
DEMO 16	WALTZ	3/4	180
DEMO 17	BOSSA	4/4	120
DEMO 18	REGGAE	4/4	110
DEMO 19	LATIN	4/4	180
DEMO 20	FLAMINGO	3/4	110

SERIAL NUMBER

--

SCC Audio Ltd

**Unit 11, Torc: MK, Chippenham Drive, Kingston,
Milton Keynes, MK10 0BZ, United Kingdom**

Tel- +44(0)1908 281072

Web: www.carlsbro.com Email: info@carlsbro.com