



177.780 **VONYX**

CX336-3 Cable 3.5mm Stereo Male - 3.5mm Stereo Male 3m

A 3 meter 3,5mm Jack stereo (M) - 3,5mm Jack stereo (M) signal cable. This flexible signal cable is fitted with Jack connectors and guarantees a trouble-free and reliable signal transmission.

Select both plugs : 3.5 mm jack (stereo) (M)

Lead length : 3m

Conductor : 10x0.12mm

Outer diameter : 4mm

Shielding : 36x0.12mm

Weight (kg) : 0,10

- Flexible cable (Jack)
- Various lengths available



Module: CSD400 / CSD500
OWNER'S MANUAL

Congratulations!

Thank you for purchasing this digital drum set. The drum set has been Developed to act and play like a drum set but with greater ease. Before you use the instrument, we recommend you to read through this manual.

Taking care of Your Digital Drum Set

Location

- Do not expose the unit to the following conditions to avoid deformation, discoloration or more serious damage.
- Direct sunlight.
- High temperature (near a heat source, or in car during the day time).
- Disconnect all cables before moving

Power Supply

- make sure to use the suitable AC adaptor, and also make sure the ac outlet voltage at your country matches the input voltage specified on the AC adaptor's label.
- Turn the power switch OFF when the Instrument is not in use.
- An AC adaptor should be unplugged from the AC outlet if the instrument is not to be used for an extended period of time.
- Unplug the AC adaptor during electric storms.
- Avoid plugging the AC adaptor into the same AC outlet as appliance with high power consumption, such as electric heaters or ovens. Also avoid using multi-plug adaptors since these can result in reducing the sound quality, operation errors, and possibly damage.

Turn Power OFF When Making Connections

- To avoid damage to the instrument and other devices to which it is connected, turn the power switches of all related device OFF prior to connecting or disconnecting cables.

Handling and Transport

- Never apply excessive force to the controls, connectors or other parts of the instrument.
- Always unplug cables by gripping the plug firmly, but not pulling on the cable.
- Disconnect all cables before moving the instrument.
- Physical shocks caused by dropping, bumping, or placing heavy objects on the instrument can result in scratches and more serious damage.

Cleaning

- Clean the unit with a dry soft cloth.
- A Slightly damp cloth may be used to remove stubborn grime and dirt.
- Never use cleaners such as alcohol or thinner.
- Avoid placing vinyl object on top of the unit (vinyl can stick to and discolor the surface).

Electrical Interference

- This instrument contains digital circuitry and may cause interference if placed too close to radio or television receivers. If this occurs, move the instrument further away from the affected equipment.

Content:

Panel description	1	Adjust pad effect	14
Front panel.....	1	EQ setting.....	14
Rear panel connection.....	2	Ambience setting.....	14
Bottom panel connection.....	2	Reload to default setting	15
LCD initial interface.....	3	Drum rim option	15
Connect with external devices	4	Demo song playing	16
Connect audio system&drum amp.....	4	Select demo song	16
Connect headphone.....	4	Select demo song.....	16
Connect MP3 or CD player.....	4	Adjust volume of accompaniment & drum.....	16
Connect PC	4	Mute Drums of demo song.....	16
Connect MIDI keyboard.....	5	Adjust demo song tempo.....	16
Power supply and switch.....	5	Record your performance	17
Basic operating	6	Recording quickly.....	17
Select drum kit.....	6	Play back performance.....	17
Play pads.....	6	MIDI setting	18
Performing	8	MIDI connection.....	18
Use metronome	8	Connect with external audio device ..	18
Adjust click.....	8	Change pad voice.....	18
Adjust click tempo.....	8	MIDI list	19
Edit and create owner's drum kit	9	Trouble shooting	21
Change pad voice.....	9	Audio source parameter	21
Change pad volume.....	9	Drum kit list	22
Change pad L/R CH pan.....	9	Voice list	23
Change MIDI output pitch.....	10	Demo song list	26
Save setting to user drum kit.....	10	Service information	27
Adjust pad Trigger	11		
Adjust pad curve.....	11		
Adjust pad threshold.....	12		
Eliminate pad crosstalk.....	12		
Adjust pad sensitivity.....	12		
Eliminate pad crosstalk.....	12		
Mask Time.....	12		
Retrig Cancel:	13		
SAVE TRIGGER SETTING	13		

Panel Description

Front panel

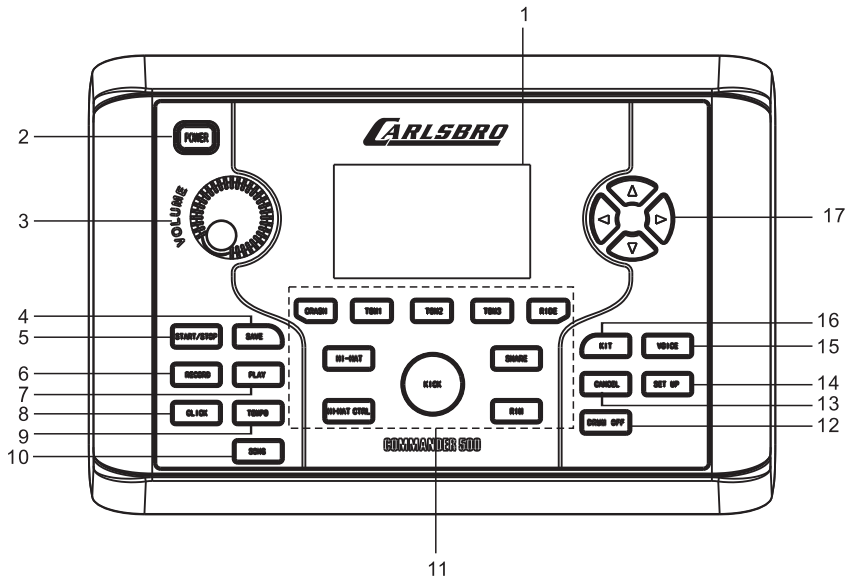

1. LCD

Displays the menu content.

2. POWER

Turns on /off the power supply.

3. VOLUME

Adjust the volume of phone and line output.

4. SAVE

Save the parameter setting.
Save the current kit setting.

5. START/STOP

Start or stop playing DEMO SONG.

6. RECORD

Record the performance.

7. PLAY

Play/pause the recorded sound.

8. CLICK

Play the metronome.

9. TEMPO

Enter into the tempo setting quickly.

10. SONG

Enter into DEMO SONG setting quickly.

11. Pad indication

Indicates the working pad or tests the pad, or set the pad parameter.

12. DRUM OFF

drum mutes when DEMO SONG is being played.

13. CANCEL

Cancel the operation or go back to the former menu.

14 SET UP

Set up metronome/drum/DEMO SONG etc.

15. VOICE

Quickly switch to voice setting.

16 KIT

Switch to drum kit quickly.

17. Direction key

▲ ▼ :Menu selection

◀ ▶ :change the parameter

(hold the button to change the value continuously.)

Rear panel connection

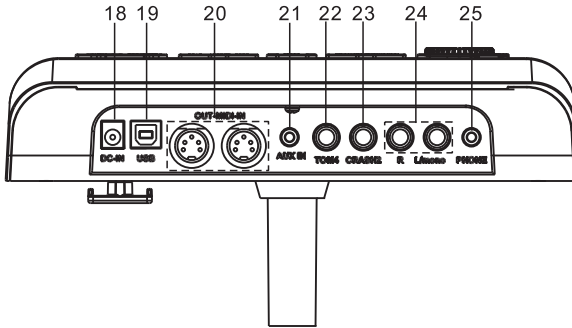

Bottom panel connection

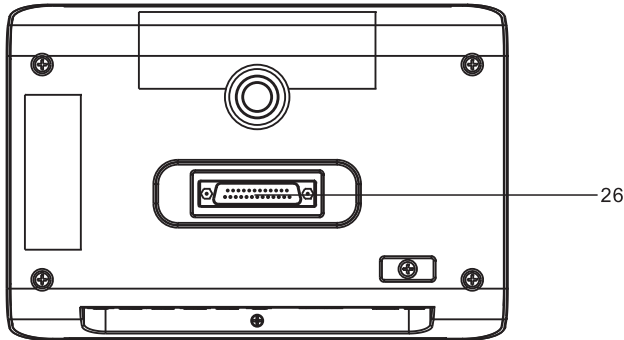

18. DC IN

Adaptor connector

19. USB

Connect with PC connector (MIDI in/out via USB)

20. IN---MIDI---OUT

Connect with the connector of external device which has MIDI.

21. AUX IN

External stereo input connector, e.g. Mp3 or CD player.

22. TOM4

Connect with TOM4

23. CRASH2

Connect with CRASH2

24 -OUTPUT- L/mono R

Connect to your audio system or amplifier, for stereo output use both the L/mono R jacks. for monaural output use the L/mono jack.

25. PHONE

Headphone output connector.

26. PAD connection

Pad signal input connector, including: KICK, TOM1--3, SNARE, RIDE, CRASH, HI-HAT CTRL

LCD initial interfaces

- 1).**CLICK=4/4**(default value when on):metronome parameter indication
- 2).**TEMPO=100**(default value when on):tempo parameter indication
- 3).**KIT01 Rock / Metal**(default value when on): drum kit indication
- 4).**SONG01**(default value when on): demo song indication
- 5).**DRUM ON**(default value when on): mutes the drum sound of demo song.



Connect with external devices

Connect to audio system or amplifier

When connecting with audio system or drum amplifier, use a cable to connect with L/mono R of the audio system and the drum amplifier.

Note:

- 1).Connect with L/mono connector when connecting with mono audio device.
- 2).Connect with L/mono and R connector when connecting with stereo audio device.
- 3).The volume is controlled by the master volume knob of module and of the audio device.

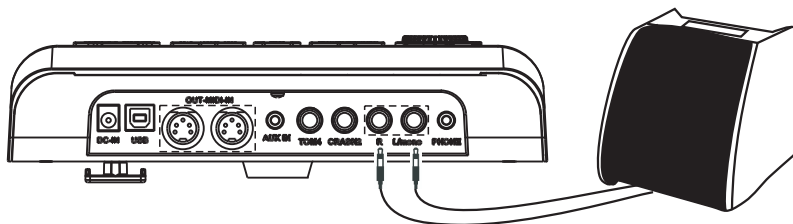

Connect to headphones

The module has 1/8" headphone connector, the volume is controlled by the volume knob of the module.

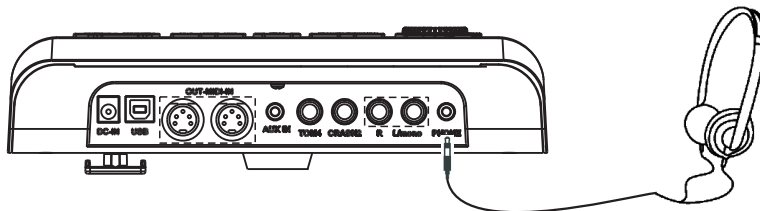

Connect to MP3 or CD player

Connect the output of MP3 or CD player or other audio sources with AUX.IN connector. The input signal can be mixed with the drum signal, strike the pads according to the rhythm of the input signal.

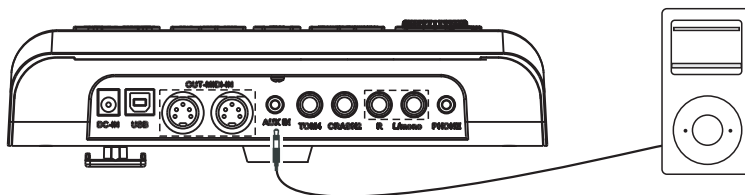

Connect to PC

1. Connect the computer via USB Receive and send MIDI signal.

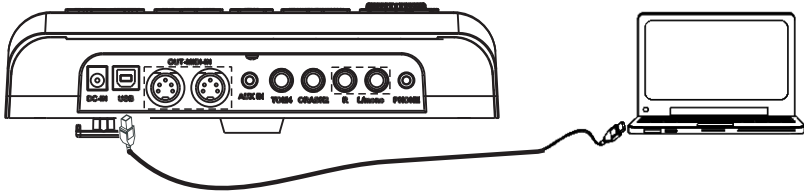

2. Connect the computer via MIDI port
 MIDI IN: receiver MIDI signal of computer.
 MIDI OUT: transmit pad performance signal to computer.

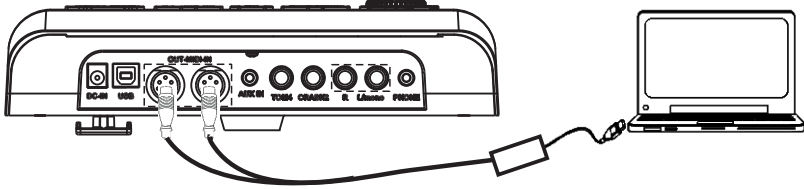

Connect with a MIDI keyboard

MIDI IN: If you're using an external MIDI keyboard or pads to control the digital drum, make connections as shown. Here, it is used as a sound module.

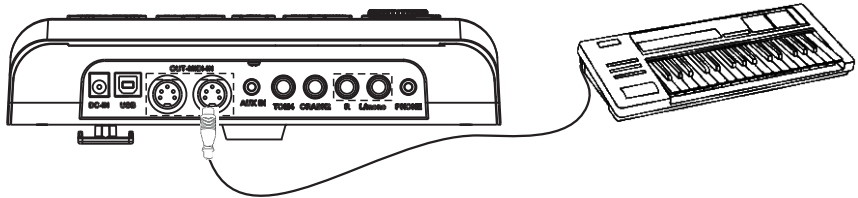

Power supply and switch

Make sure the power is switched OFF. Connect the power adaptor to the DC IN jack on the rear panel. After confirming that all connections have been completed, rotate the volume knob to the left (minimum volume level) before switching the power on. Set the power switch to the “ON” position. The KIT indicator on LCD will light up and the display will show kit number 01: KIT 01 Rock /Metal.

Note:

Make sure the power is switched OFF when connecting the drum module with external devices.

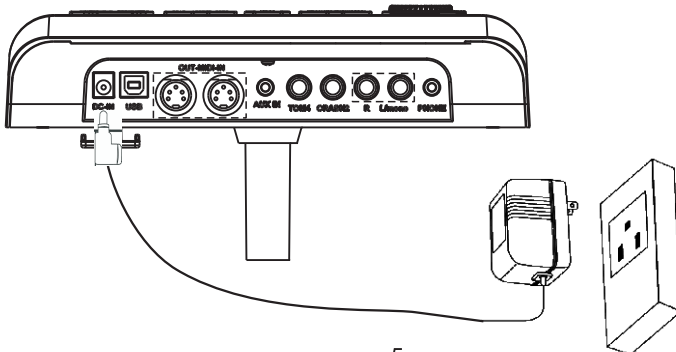

Basic operating

Select a drum kit

After powering up, the digital drum will be in kit menu (kit indicator on). the display should look like the following figure. if not, press“KIT” on front panel or use the direction key ▲▼ to select the active kit.

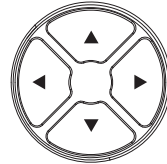
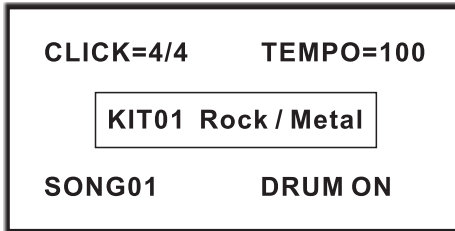

1. Use the direction key ◀ ▶ to select drum kit. 41 sets of drum kits in all.
29 sets of preset drum kits: KIT01---29
12 sets of user drum kits: USER01---12
2. Pressing the Pad indication allows you to preview the current kit (fixed velocity).
3. Hit the pads to play the current kit.

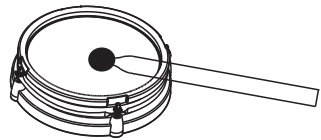

Play pads

Similar to an acoustic drum kit, the digital drum responds differently to various playing techniques and dynamics. All the pads sense the striking force. and some voices change tone depending on the striking force.

Drum pad and rim shot

The digital drum pad detects head and Side stick (Side stick are different from the pad shots).

Note:

1. SNARE and TOM1-TOM3 are dual channels.
2. RIDE: it delivers RIDE BELL sound when hit strongly, and RIDE CYMBAL sound when hit slightly.
3. SNARE delivers one sound when hit the pad rim strongly.

Cymbal bow shot and choke

CRASH and RIDE have the bow shot and choke, e.g. hit the cymbal or the rim then hold the rim to choke (stop) the sound.



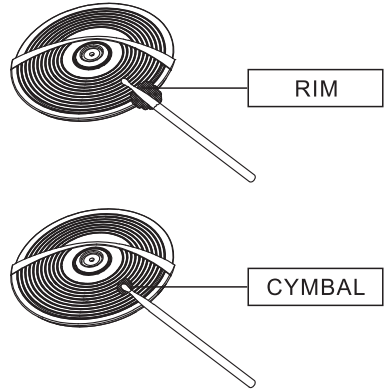
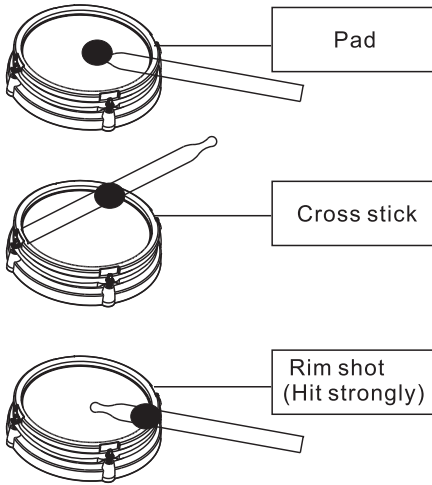

HI-HAT

The Hi-Hat sound varies depending on the position of the Hi-Hat pedal:

Open Hi-Hat: Strike the Hi-Hat pad without pressing the pedal.

Closed Hi-Hat: Strike the Hi-Hat pad with the pedal pressed completely down.

Pedal Close: Press the pedal completely down without striking the pad.

Half-open Hi-Hat: Strike the Hi-Hat pad with the pedal pressed halfway down

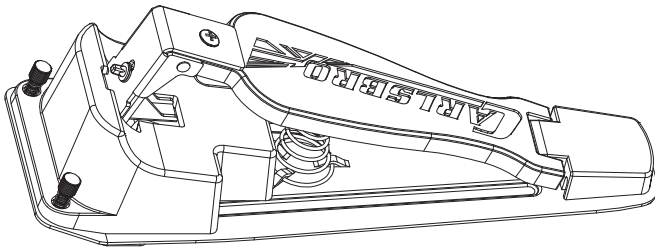

Performing

Use the metronome

1. User can use the [CLICK] button to turn on/off metronome.
2. Use the direction key ▲▼ to select the click items to reset.



Adjust the click

3. When the metronome plays at the click and tempo, such as the LCD displays, the CLICK flashes, user can use the direction key ◀▶ to change click.
4. In the click item, press [SET UP] button to set click tone parameters.

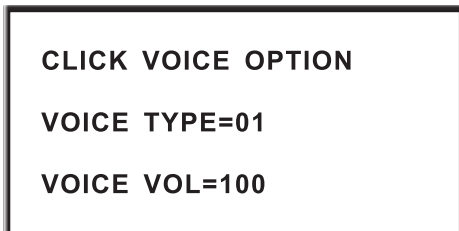

- 1).VOICE TYPE=01 user can adjust the voice type (01---03)
- 2).VOICE VOL=127 user can adjust the voice volume (000---127)

Adjust click tempo

User can adjust the click tempo. When playing metronome, press tempo to adjust from 030-300 bpm.

- 1.Press [TEMPO] to adjust tempo speed.
- 2.Use the direction key ◀▶ to change tempo speed.

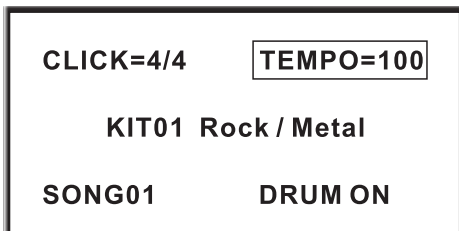

Edit and create owner's drum kit

In the drum kit menu, user can change parameter according to the playing style then save it.

1. Press [KIT] to select the drum kit
2. Use the direction key ◀ ▶ to switch to the desired drum kit to edit.
3. Press [SET UP] to enter drum pad setting, and DRUM PAD SETTING contrast color.

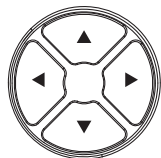

DRUM PAD SETTING

PAD TRIGGER
RELOAD FAC SET
EFFECT
DRUMRIM OPTION

VOICE=ESN_04
VOLUME=080
PAN=084
MIDI PITCH=044

4. Select pad via pad indication button or hit the pads.

Change pad voice

5. Press [SET UP] again to enter tone parameter setting.
6. Use direction key ◀ ▶ to select tone.
(Note: refer to the tone list for tone)

Change pad volume

7. Use direction key ▲ ▼ to select VOLUME item.
8. Use direction key ◀ ▶ to change volume.

Change pad L/R channel position

9. Use direction key ▲ ▼ to select PAN
10. Use direction key ◀ ▶ to change L/R Channel position.
(GM standard: 000---127)

Change MIDI output pitch value

11. Use direction key ▲▼ to select MIDI PITICH
12. Use direction key ◀▶ to change MIDI output pitch value(000---127)
(when adjusting parameter, press [SET UP] button to reset all parameters back to default status)

Save setting to user drum kit

13. Press [SAVE] to save setting to user drum kit.
14. Use direction key ◀▶ to select user drum kit(01---12)
15. Press [SAVE] button to save or press [CANCEL] button for undo

SAVE CHANGE
FOR USER01
PRESS SAVE FOR YES
PRESS CANCEL FOR NO

Adjust pad Trigger

1. Use the direction key ▲▼ to switch to PAD TRIGGER
2. Press [SET UP] to enter pad parameter setting.
3. Use direction key ▲▼ to select trigger parameter.
4. Use direction key ◀▶ to change trigger parameter.
(Press direction key ◀▶ simultaneously to return to the preset value)

DRUM PAD SETTING
PAD TRIGGER
 RELOAD FAC SET
 EFFECT
 DRUMRIM OPTION

Adjusting pad curve

Pad curve is relative to the pad dynamic signal.

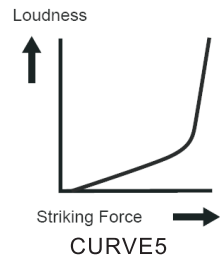
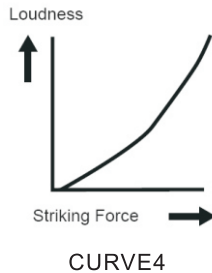
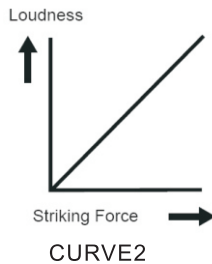
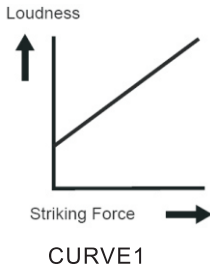

PAD HIHAT
 PAD CURVE=3
 THRSHTD=2
 CROSSTALK=04
 SENSITIVITY=08
 MASK TIME=18
 RETRIG CANCEL=10

CURVE 1: very low dynamic response, high volume. If used to trigger the pads, the curve is flat.
 CURVE2: the standard setting, during playing or when volume changes, it generates maximum natural signal.

CURVE3: compared to CURVE2, weak force generates relatively big change.

CURVE4: compared to CURVE2, strong force generates relatively big change.

CURVE5: compared to CURVE2, strong force generates very big change.

Adjust pad threshold

Threshold: the minimum force to trigger a pad signal.

Setting a high threshold, the pad needs a strong force to generate a signal. This can avoid accidental response, e.g. other device or pad generating unnecessary signal.

Setting a low threshold, the pad only needs a weak force to generate a signal.

User can adjust threshold based on performing style.

Threshold range: 1---8

Eliminate pad crosstalk

When two pads are close, hitting one pad can cause the other pad to generate a signal. This crosstalk can be eliminated by setting a high parameter of the other pad.

Crosstalk range: 0---10

Note

If the crosstalk value is set too high, when two pads are played simultaneously the one that is struck less forcefully will not sound, so be careful and set this parameter to the minimum value required to prevent such crosstalk.

Adjust pad sensitivity

Sensitivity: 1-16

You can adjust the sensitivity of the pads to accommodate your personal playing style. This allows you to have more dynamic control over the sound volume, based on how hard you play.

Higher sensitivity allows the pad to produce a loud volume even when played softly.

Lower sensitivity will keep the pad producing a low volume even when played strongly.

(Press direction keys simultaneously to return to the preset value)

Double Triggering Prevention(Mask Time)

Mask Time: 0-64(ms)

This setting allows you to prevent double trigger

When playing a kick trigger the beater can bounce back and hit the head a second time immediately after the intended note. This causes a single hit to “double trigger”(two sounds instead of one). The Mask Time setting helps to prevent this. Once a pad has been hit, any additional trigger signals occurring within the specified “Mask Time”(0-64 msec) will be ignored.

When using a kick trigger, try to let the beater bounce back and hit the head very quickly, then raise the “Mask Time” value until there are no more sounds made by the beater rebound.

Note:

1. When set to a high value, it will be difficult to play very quickly. Set this to as low a value as you can
2. If two or more sounds are being produced when you strike the head just once, then adjust Retrig Cancel.

Retrig Cancel: 01-16

This setting allows you to prevent re-trigger (Re-trigger)

Important if you are using acoustic drum triggers. Such triggers can produce altered waveforms, which may also cause inadvertent sounding at Point A in the following figure (Retrigger)

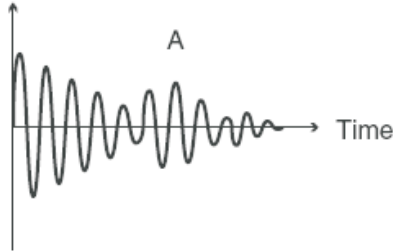

This occurs in particular at the decaying edge of the waveform. Retrigger Cancel detects such distortion in and prevents retriggering from occurring.

While repeatedly striking the pad, raise the “Retrig Cancel” value until retriggering no longer occurs.

NOTES:

1. Although setting this to a high value prevents retriggering, it then becomes easy for sounds to be omitted when the drums are played fast (roll etc.). Set this to the lowest value possible while still ensuring that there is no retriggering.
2. You can also eliminate this problem of retriggering with the Mask Time setting. Mask Time does not detect trigger signals if they occur within the specified amount of time after the previous trigger signal was received. Retrigger Cancel detects the attenuation of the trigger signal level, and triggers the sound after internally determining which trigger signals were actually generated when the head was struck, while weeding out the other false trigger signals that need not trigger a sound.

SAVE PAD TRIGGER SETTING

After all PAD TRIGGER parameters have been set, you can save your setting. Press SAVE to save setting or press [CANCEL] button to undo changes

SAVE CURRENT
TRIGGER SETTING
PRESS SAVE FOR YES
PRESS CANCEL FOR NO

Adjust pad effect

1. Use the direction key ▲ ▼ to switch to EFFECT
2. Press [SET UP] to enter pad effect setting.

DRUM PAD SETTING

PAD TRIGGER

RELOAD FAC SET

EFFECT

EQ setting

3. Use the direction key ▲ ▼ to select EQ setting, it's always a 3 band EQ type.
4. Use the direction key ◀ ▶ to change EQ value.
HI GAIN=12(default) range:01---25
MID GAIN=18(default) range:01---25
LOW GAIN=20(default) range:01---25

HI GAIN=12

MID GAIN=18

LOW GAIN=20

AMBIENCE=OFF

Ambience setting

5. Use the direction key ▲ ▼ to select AMBIENCE
6. Use the direction key ◀ ▶ to switch AMBIENCE
AMBIENCE=OFF
AMBIENCE=01
AMBIENCE=02

HI GAIN=12

MID GAIN=18

LOW GAIN=20

AMBIENCE=OFF

Reload default setting

1. Use the direction key ▲ ▼ to select RELOAD FAC SET
2. Press [SET UP] to go back to the default setting.
3. Use the direction key ◀ ▶ to select saved drum kit.
e.g. FOR USER01
4. Press [SET UP] to the default setting
5. Press [CANCEL] to cancel the default setting

RELOAD SETTING
FOR USER01
SET UP FOR YES
CANCEL FOR NO

Drum rim option

1. Use the direction key ▲ ▼ to select Drum rim option
2. Press [SET UP] to enter Drum rim setting.
3. Use the direction key ▲ ▼ to select TOM RIM or
SNARE RIM
4. Use the direction key ◀ ▶ to change option.
5. ON: one sound when hit the pad rim
OFF: no sound when hit the pad rim

PAD TRIGGER
RELOAD FAC SET
EFFECT
DRUMRIM OPTION

TOM RIM = ON
SNARE RIM = ON

Demo song playing

Select demo song

1. Press [SONG] to switch to DEMO SONG menu or use the direction Key ▲▼ to select SONG01
2. Use the direction key ◀▶ to select the preset DEMO SONG
3. Press [START/STOP] to play the selected song

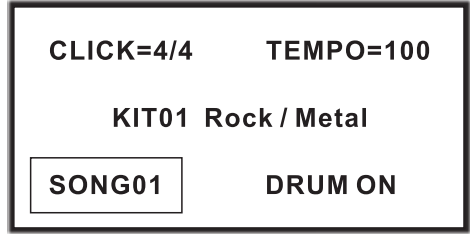

(refer to DEMO SONG LIST for the DEMO SONG)

Adjust volume of accompaniment & drum

4. Press [SET UP] to enter accompaniment and drum volume setting.
ACC VOLUME: Use the direction key ◀▶ to adjust DEMO SONG accompaniment volume.
DRUM VOLUME: Use the direction key ◀▶ to adjust DEMO SONG drum volume.



Mute drums of demo song

1. When playing DEMO SONG and you want to mute the Drums of the DEMO song, use the direction key ▲▼ to select DRUM ON. use the direction key ◀▶ to switch to DRUM OFF
2. Press [DRUM OFF] button once to change.



Adjust demo song tempo

When playing, first use the direction key ▲▼ to select "TEMPO", then use the direction key ◀▶ to adjust DEMO SONG tempo.

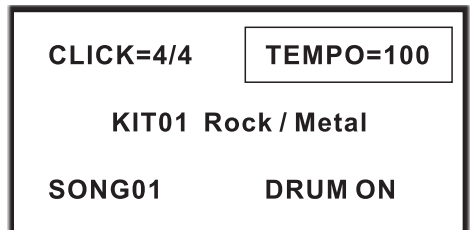

Record your performance

You can record pad performances and the Drums of demo song.

Record quickly

1. Press [RECORD]. Recording LED lights up,
2. Strike pad to record or record the drum section of the song.
3. Press [RECORD] again to stop recording. Recording LED lights off. Your performance or the drum section has been recorded.

CLICK=4/4 TEMPO=100

KIT01 Rock / Metal

SONG01 DRUM ON

(Note: when recording, you need to turn on DRUM ON, that is to switch DRUM OFF to DRUM ON)

Play back performance

1. Press [PLAY].LED flashes once. It plays the recorded performance.
2. Press [PLAY] again to stop playing.
3. If you are unsatisfied with the recorded performance, press [RECORD] to record once again. (Note: it can record the performance but can not save. This means the recorded performance will replace the former recorded performance)

MIDI setting

This device is compatible with various MIDI devices. When it is used as trigger device or audio source, it is compatible with GM standard, and can be used with most sequencer software.

MIDI connection

MIDI IN: inputs MIDI signal when connecting with external MIDI device

MIDI OUT: outputs MIDI signal when connecting with external MIDI device

USB: standard USB2.0 interface. connect with USB to a PC. The operation system has relative driver without the need to install again. Compatible with the PC system, e.g. from XP up to Win10, Mac OSX . After connection, the system recognizes this device as USB AUDIO DEVICE.

Note: 1.USB only used for MIDI connection

2. When USB connects with PC, all MIDI data will be received and transmitted via USB

Connect with external audio device

This device automatically connects via channel 10 transfers drum signal to other MIDI device, including notes, forces, pedal performance, etc.

(Note: Song playback data and metronome notes are not transferred)

Record your performance with external sequencer

1. Connect with external sequencer or PC via MIDI OUT and IN for playback or USB interface.
2. Use the sequencer or the software to set channel 10 as a device to start recording.
3. Play the drum pads.
4. Stop performance and recording. Playback the recording.

Setting MIDI note number to be transferred/received by each pad

1. Press VOICE button to enter the VOICE menu.
2. Strike the relative pad, use direction key to select MIDI PITCH
3. Use the left/right key to MIDI value for a pad.
4. Press save button to save USER drum kit.

Default factory setting as below:

TRIGGER	NOTE	TRIGGER	NOTE	TRIGGER	NOTE
KICK	36	TOM3	43	CRASH2 RIM	52
SNARE	38	TOM3 RIM	58	RIDE	51
SNARE RIM	37	TOM4	41	RIDE RIM	59
TOM1	48	TOM4 RIM	39	HI-HAT PEDAL	44
TOM1 RIM	50	CRASH1	49	HI-HAT OPEN	46
TOM2	45	CRASH1 RIM	55	HI-HAT CLOSED	42
TOM2 RIM	47	CRASH2	57		

MIDI list

FUNCTION		TRANSMITTED	RECOGNIZED	REMARKS
BASIC CHANNEL	DEFAULT	10 Ch	1---16	
	CHANGED	x	x	
MODE	DEFAULT	x	x	
	MESSAGES	x	x	
	ALTERED	x	x	
NOTE NUMBER	TRUE VOICE	*****	0---127	
		*****	0---127	
VELOCITY	NOTE ON	○ 99H.V=1---1	○	
	NOTE OFF	x	○	
AFTER TOUCH	KEY'S	x	x	
	CH'S	x	x	
PITCH BEND		x	x	
CONTROL CHANGE	0	x	○	BANK SELECT
	1	x	x	MODULATION
	5	x	x	PORTAMENTO TIME
	6	x	○	DATA ENTRY
	7	x	○	VOLUME
	10	x	○	PAN
	11	x	x	EXPRESSION
	64	x	○	SUSTAIN PEDAL
	65	x	x	PORTAMENTO ON/OFF
	66	x	x	SOSTENUTO PEDAL
67	x	x	SOFT PEDAL	

	80	x	○	REVERB PROGRAM
	81	x	○	CHORUS PROGRAM
	91	x	○	REVERB LEVEL
	93	x	○	CHORUS LEVEL
	120	x	○	ALL SOUND OFF
	121	x	○	RESET ALL CONTROLLERS Controllers
	123	x	○	ALL NOTES OFF
		x	○	
		x	0-127	
System Exclusive		x	x	
System	:Song Position	x	x	
Common	:Song Select	x	x	
	:Tune	x	x	
System	:Clock On/Off	○	x	START AND STOP ONLY
Real Time	:Commands		x	
Aux	:Local	x	x	
	:All Notes Off	x	x	
Message	:Active Sensing	x	x	
	:Reset	x	x	

Trouble shooting

Problem	Reason or solution
No sound	Confirm the volume is not turned off
Pad had no sound	1.confirm the correct connection of pad 2.confirm pad volume is not set to 0
Metronome has no sound	Confirm the metronome volume is not set to 0
DEMO SONG has no sound	Confirm DEMO SONG volume is not set to 0

Audio source specifications

Polyphony 64

Drum kits:

29 preset drum kits:KIT01---29

12 user drum kits:USER01---12

Voice

358 kinds of voices(DRUMS, PERCUSSION ,SFX)

Effects:

2 kinds of ambience setting, 3 band EQ

Sequencer

DEMO SONG:20 pcs

Recording: real time recording, can not be saved

Tempo:030---300

Connection

Multipin connector for pads, headphone stereo out connectors (1/4"),AUX IN stereo connector (1/8"), 2 link connectors(1/4" TOM4,CRASH2),audio output connector(1/4" L/mono R),USB, MIDI IN/MIDI OUT

CSD500: internal rechargeable lithium battery: 5200mAh/3.6V

CSD400: without internal rechargeable lithium battery

(the specification is subject to change without prior notice.)

Drum kit list

No	Preset drum kit	No	User drum kit
KIT01	ROCK/METAL	USER01	ROCK/METAL
KIT02	POP/FUNK	USER02	POP/FUNK
KIT03	JAZZ	USER03	JAZZ
KIT04	POP1	USER04	POP1
KIT05	POP2	USER05	POP2
KIT06	POP3	USER06	POP3
KIT07	POP4	USER07	POP4
KIT08	ROCK1	USER08	ROCK1
KIT09	ROCK2	USER09	ROCK2
KIT10	ROCK3	USER10	ROCK3
KIT11	METAL1	USER011	METAL1
KIT12	METAL2	USER12	METAL2
KIT13	HIHOP		
KIT14	FUNK1		
KIT15	FUNK2		
KIT16	FUNK3		
KIT17	LATIN1		
KIT18	LATIN2		
KIT19	LATIN3		
KIT20	JAZZ1		
KIT21	JAZZ2		
KIT22	JAZZ3		
KIT23	BRUSH		
KIT24	ORCH		
KIT25	DANCE1		
KIT26	DANCE2		
KIT27	EAST1		
KIT28	EAST2		
KIT29	PERC		

Voice list

ACOUSTIC BASS DRUM	
1	KICK1
2	KICK2
3	KICK3
4	KICK4
5	KICK5
6	KICK6
7	KICK7
8	KICK8
9	KICK9
10	KICK10
11	KICK11
32	JAZZBD1
33	JAZZBD2
40	ORCHBD1
41	ORCHBD2
42	ORCHBD3

ELEC. BASS DRUM	
12	DNCBD1
13	DNCBD2
14	LOBD
15	SYNBD01
16	SYNBD02
17	SYNBD03
18	EKICK01
19	EKICK02
20	EKICK03
21	EKICK04
22	EKICK05
23	EKICK06
24	EKICK07
25	EKICK08
26	EKICK09
27	EKICK10
28	ETBD
29	HARDBD
30	HIKICK
31	HRTBEAT
34	LOFIBD
35	LONGBD1
36	LONGBD2
37	LONGBD3
38	LTBD1
39	NOISEBD
43	SPACEBD1
44	SPACEBD2

ACOUSTIC SNARE	
92	BRSHSN1
93	SWEEP
108	SNSTD
109	FNKSN1
110	FNKSN2
111	HRDBT
112	STDROCK
113	JZSLP1
114	JZSLP2
115	JZSLP3
116	HARMONIC
117	ORCHSN1
118	ORCHSN2
119	ORCHSN3
120	SDSTK1
121	SDSTK2
122	SDSTK3
123	SDSTK4
124	SRIM1
125	SRIM2
126	SRIM3
127	POPSNR
128	RIMCOMBO
129	SNSDHD
130	SNRIMLT
131	HVSN
132	TITESN1
133	TITESN2
134	TITESN3
135	TITESN4
136	TITESN5
137	TRDSN1
138	TRDSN2

ELEC. SNARE	
94	SYNSN01
95	SYNSN02
96	SYNSN03
97	ESN01
98	ESN02
99	ESN03
100	ESN04
101	ESN05
102	ESN06
103	ESN07
104	ESN08

105	ESN09
106	ESN10
107	ESN11

ACOUSTIC HI-HAT	
45	CHHSTD
46	CHH1
47	CHH2
48	CHH3
49	CHH4
50	CHH5
51	CHH6
52	CHH7
53	CHH8
70	LOOSHH1
71	LOOSHH2
72	LOOSHH3
73	LOOSHH4
74	LOOSHH5
75	LOOSHH6
76	OHHSTD1
77	OHHSTD2
78	OHIHAT1
79	OHIHAT2
80	OHIHAT3
81	OHIHAT4
82	OHIHAT5
83	OHIHAT6
84	OHIHAT7
85	OHIHAT8
86	PHH1
87	PHH2
88	PHH3
89	PHH4
90	PHH5
91	PHH6

ELEC. HI-HAT	
54	EHH01
55	EHH02
56	EHH03
57	EHH04
58	EHH05
59	EHH06
60	EHH07
61	EHH08
62	EHH09
63	EHH10

Voice list

64	EHH11
65	EHH12
66	EHH13
67	EHH14
68	EHH15
69	EHH16

ACOUSTIC TOM	
139	BRSHT1
140	BRSHT2
141	BRSHT3
147	TOMLO
148	TOM1H
149	TOM1M
150	TOM1L
151	TOM2H
152	TOM2M
153	TOM2L
154	TOM3H
155	TOM3M
156	TOM3L
157	FLTMSTD
158	JZTOM1
159	JZTOM2
160	JZTOM3
161	TOM4
162	TOM5
163	TOM6
164	TOM7
165	TOM8
166	TOM9
167	TOM10
168	TOMHSTD
169	TOMLSTD
170	TOMMSTD
171	TOMFL1
172	TOMFL2
173	TOMFL3

ELEC. TOM	
142	808T1
143	808T2
144	808T3
145	ETOM01
146	ETOM02
174	XEDRUM1

ACOUSTIC CYMBAL	
-----------------	--

175	CRASH1
176	CRASH2
177	CRASH3
178	CRASH4
179	CRASH5
180	CRASH6
181	CRASH7
182	CRASH8
183	CRASH9
184	CRASH10
185	CRASH11
186	CRASH12
187	CRASH13
188	CRSHJS1
189	CRSHJS2
190	CRSHSTD1
191	CRSHSTD2
195	LTCRSH
196	ORCCYM1
197	ORCCYM2
198	CRASH18
199	RIDE20
200	RBLL1
201	RBLL2
205	RIDEJZ1
206	RIDEJZ2
207	RIDE1
208	RIDE2
209	RIDE3
210	RIDE4
211	RIDE5
212	RIDE6
213	RIDE7
214	RIDE8
215	SPLSH1
216	SPLSH2
217	SPLSH3
218	SPLSH4

ELEC. CYMBAL	
192	ECRASH1
193	ECRASH2
194	ECRASH3
202	REVCYM1
203	REVCYM2
204	REVCYM3

PERCUSSION	
269	SNATCH
270	BLLTREE
271	CABASA1
272	CABASA2
273	CABASA3
274	CABASA4
275	CHKR01
276	CHKR02
277	CHKR03
278	CHKR04
279	CHKR05
280	CLAP1
281	CLAP2
282	CLKBLL
283	CLV
284	COWBLL01
285	COWBLL02
286	COWBLL03
287	COWBLL04
288	COWBLL05
289	COWBLL06
290	COWBLL07
291	COWBLL08
292	COWBLL09
293	COWBLL10
294	COWBLL11
295	COWBLL12
296	COWBLL13
297	HAGOGO1
298	HAGOGO2
299	HAGOGO3
300	HAGOGO4
301	HIBNGO01
302	HIBNGO02
303	HTMBL1
304	HTMBL2
305	HTMBL3
306	HTMBL4
307	HTMBL5
308	HTMBL6
309	HTMBL7
310	HTMBL8
311	HWBLK
312	LOTMBL
313	LAGOGO
314	LGUIRO
315	LOBNGO

Voice list

222	EMRCA1
223	EMRCA2
224	EMTRI
225	ETRNL1
226	ETRNL2
227	EBELL1
228	EBELL2
229	ECBSA1
230	ECBSA2
231	ECLAP1
232	ECLAP2
233	ECLAP3
234	ECLAP4
235	ECLAP5
236	ECLAP6
237	ECLAP7
238	ECLAP8
239	ECLAP9
240	ECLAP10
241	EDOWN
242	ECLAVE
243	ECLICK1
244	ECLICK2
245	ECLICK3
246	ECLICK4
247	ECLICK5
248	ECOWBLL
249	ESHKR01
250	ESHKR02
251	ESHKR03
252	ESHKR04
253	ESHKR05
254	ESHKR06
255	ESHKR07
256	ESLAP1
257	ESLAP2
258	ESTICK1
259	ESTICK2
260	ETMBRIN1
261	ETMBRIN2
262	MACHINE1
263	MACHINE2
264	MACHINE3
265	MACHINE4
266	MONO
267	PING
268	SCRACH

316	LOCNGA
317	LWBLK
318	LWHSL1
319	MCUICA
320	MHCNGA
321	MRCAS
322	MTRNGL
323	OCUICA
324	OHCNGA01
325	OHCNGA02
326	OHCNGA03
327	OPNTRNGL
328	SGUIRO
329	SWHSL
330	TMBRN1
331	TMBRN2
332	TMBRN3
333	TMBRN4
334	VSLP
335	CNBGONG
336	CNLCYMBL
337	CNLDRM1
338	CNLDRM2
339	CNSCYMBL
340	CNSDRM
341	CNSGONG
342	SUPRGNG
343	TAIKO1
344	TAIKO2
345	TAIKO3
346	TAIKOSD1
347	TAIKOSD2
348	CHIM1
349	CHIM2
350	SNAP
351	STICK1
352	STICK2
353	TIM1
354	TIM2
355	TIM3
356	TIM4
357	TMPNS
358	WNDCHM

ELEC. PERCUSSION	
219	BOLLY
220	CLAP
221	DOWN

Demo song list

No	Song	Type
01	SONG01	8BEAT
02	SONG02	16BEAT
03	SONG03	DISCO
04	SONG04	WALTZ
05	SONG05	SLOW ROCK
06	SONG06	ROCK BLUES
07	SONG07	COUNTRY ROCK
08	SONG08	HARD ROCK
09	SONG09	FUSION
10	SONG10	JAZZ BLUES
11	SONG11	FUNK
12	SONG12	COUNTRY
13	SONG13	COUNTRY
14	SONG14	COUNTRY
15	SONG15	BLUES
16	SONG16	JAZZ
17	SONG17	JAZZ
18	SONG18	JAZZ
19	SONG19	SMOOTH JAZZ
20	SONG20	BOSSA

Service information

If you have a problem with your Carlsbro product or think it has developed a fault you should first carefully check the Trouble Shooting section in this guide. If this does not solve the problem or if the product is physically damaged, contact your local dealer or distributor for service details.

Should it be recommended you return the product to your nearest Carlsbro Service Centre you must first contact them.

You will be asked for the product type and serial number. You will then be given a returns Authorisation (RA) number. Pack the unit in its original carton to protect it from shipping damage.

You must have the Returns Authorisation number clearly marked on the outside of the carton or we may refuse the delivery.

Carlsbro cannot be held responsible for damage resulting from the equipment being packed incorrectly.

Label the equipment clearly with your name and address and include a clear description of the fault. The more information you supply helps the service engineer, minimising repair cost when out of warranty.

Please write your serial number here for future reference.

SCC Audio Ltd

Unit 11, Torc: MK, Chippenham Drive, Kingston,
Milton Keynes, MK10 0BZ, United Kingdom
Tel- +44(0)1908 281072

Web: www.carlsbro.com Email: info@carlsbro.com