

EDA 50

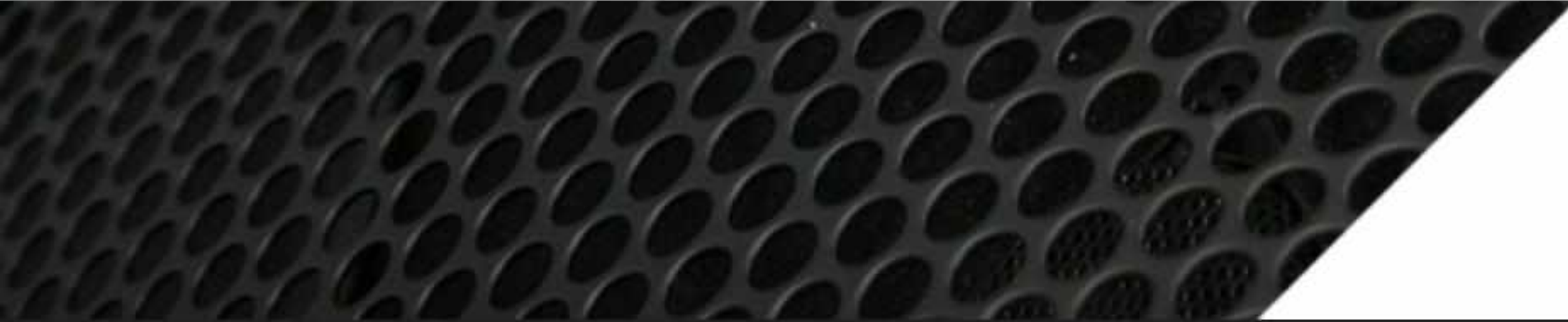

Today's digital drum technology creates multiple tones at a very broad range of frequencies that all have to be heard simultaneously. Those distinctive sounds generated from the snare drum, tom-toms, bass drum and cymbals are all heard in the same way as the acoustic kit. We are proud of the EDA Series as they perform like a true drum amplifier should, delivering those rich, broad tones that inspire you to play more. We strongly recommend the EDA2005 for that powerful sound projection, but if you are on a budget or space is tight go for the EDA50.

product Specification

- 2 Channel Inputs
- Built-in 50 watt power amplifier
- 3 Band EQ
- Aux Input
- 10" bass driver plus tweeter
- Full metal grille for speaker protection



Today's digital drum technology creates multiple tones at a very broad range of frequencies that all have to be heard simultaneously. Those distinctive sounds generated from the snare drum, tom-toms, bass drum and cymbals are all heard in the same way as the acoustic kit.

drum Technology



Module: CSD600
OWNER'S MANUAL

Congratulations!

Thank you for purchasing this digital drum set. The drum set has been developed to act and play like a drum set but with greater ease. Before you use the instrument, we recommend you to read through this manual.

Taking care of Your Digital Drum Set

Location

- Do not expose the unit to the following conditions to avoid deformation, discoloration or more serious damage.
- Direct sunlight.
- High temperature (near a heat source, or in car during the day time).
- Disconnect all cables before moving

Power Supply

- make sure to use the suitable AC adaptor, and also make sure the ac outlet voltage at your country matches the input voltage specified on the AC adaptor's label.
- Turn the power switch OFF when the Instrument is not in use.
- An AC adaptor should be unplugged from the AC outlet if the instrument is not to be used for an extended period of time.
- Unplug the AC adaptor during electric storms.
- Avoid plugging the AC adaptor into the same AC outlet as appliance with high power consumption, such as electric heaters or ovens. Also avoid using multi-plug adaptors since these can result in reducing the sound quality, operation errors, and possibly damage.

Turn Power OFF When Making Connections

- To avoid damage to the instrument and other devices to which it is connected, turn the power switches of all related device OFF prior to connecting or disconnecting cables.

Handling and Transport

- Never apply excessive force to the controls, connectors or other parts of the instrument.
- Always unplug cables by gripping the plug firmly, but not pulling on the cable.
- Disconnect all cables before moving the instrument.
- Physical shocks caused by dropping, bumping, or placing heavy objects on the instrument can result in scratches and more serious damage.

Cleaning

- Clean the unit with a dry soft cloth.
- A Slightly damp cloth may be used to remove stubborn grime and dirt.
- Never use cleaners such as alcohol or thinner.
- Avoid placing vinyl object on top of the unit (vinyl can stick to and discolor the surface).

Electrical Interference

- This instrument contains digital circuitry and may cause interference if placed too close to radio or television receivers. If this occurs, move the instrument further away from the affected equipment.

Content:

FUNCTION BUTTON	1
Front panel.....	1
Rear panel	3
CONNECTING WITH EXTERNAL DEVICES	4
Connect audio system or drum amp.....	4
Connect with headphone.....	4
Connect MP3 or CD player.....	5
Connect with computer.....	5
Connect with MIDI keyboard	6
Connect with power supply.....	6
PERFORMANCE	7
Trigger.....	7
Hi-hat	8
cymbal.....	9
BASIC OPERATION	9
change the value.....	9
elect to edit the trigger	10
Using fader.....	10
ormal mode and coach mode switching.....	10
NORMAL mode.....	10
COACH.....	13
UTILITY SETTING	14
TRIGGER setting	14
CLICK setting	17
EFFECT setting	17
COACH: the difficulty setting of coach function	19
USB STORAGE setting	20
SYSTEM setting	22
EDIT AND SAVE USER DRUM KIT ..	22
Drum kit information	22
Edit and save drum kit voice	22
Import from USB to user drum kit	24
Set user drum kit back to factory mode ..	25
PLAYING SONGS	26
RECORDING FUNCTION	27
USB recording	28
Replay the recorded information ...	28
COACH MODE	29
Coach mode level selection.....	30
Enter into coach mode	30
Select song	31
Play/stop	31
Play with the song and record	31
MIDI SETTING	31
About MIDI.....	31
MIDI setting.....	32
Connect with external audio source equipment	32
Used as audio source device.....	33
MIDI list	34
Trouble shooting	35
Drum kit list	37
VOICE	38
GM drum kit list	41
DEMO SONG LIST	43
Service information	45

FUNCTION BUTTON

Front panel

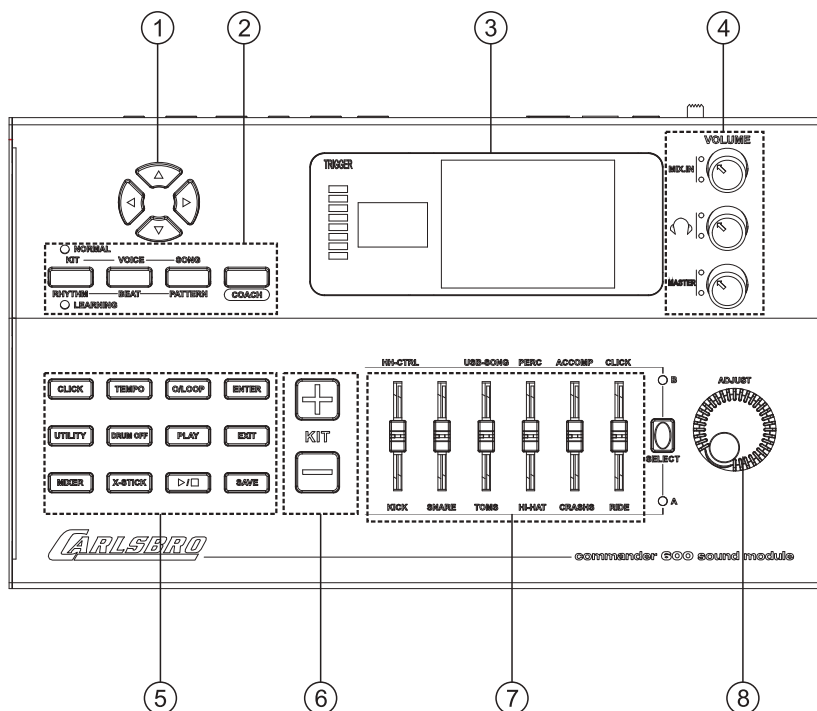

Number	Name	Description
①	CURSOR	^ v: former/next menu option < >: left/right menu option
②	COACH	Switch the normal mode and practice mode. the relative LED lights up when switching.
	KIT/RHYTHM	Enter into the drum kit page in normal mode, and enter into the rhythm practice page in practice mode.
	VOICE/BEAT	Enter into voice page in normal mode. Enter into snare practice mode in practice mode.
③	SONG/PATTERN	Enter into demo song page in normal mode. Enter into drum kit practice mode in practice mode.
	LCD display	Trigger level display: weak to strong, LED from green to yellow to red LED digitron: displays the relative drum kit or other number LCD display: menu content

④	MIX IN	Adjusts the module level of MIX IN connector
	PHONE	Adjust the output headphone volume
	MASTER	Adjust the master volume
⑤	MIX OFF	Cancel mixed volume, reset drum kit to preset volume
	CLICK	The switch of playing metronome
	TEMPO	Enter into tempo setting quickly
	X-STICK	Controls if trigger Tom rim during striking
	DRUM OFF	Mute the drum
		Start/stop DEMO SONG playing
	REC	Enter into recording status
	PLAY	Play/pause the recording sound
	SAVE	Save the current setting
	UTILITY	Enter into utility setting interface
	ENTER	Enter into the next interface
EXIT	Exit the current operation and return to the former operation interface.	
⑥	+/-	Switch drum kit , +: increase; -: decrease
⑦	Fader	Fader is used to adjust the relative volume: bass drum, snare, Tom, hi-hat, other percussion instrument, metronome, USB song, accompaniment, etc.
⑧	ADJUST	Knob function: the knob can change the editing value.

Rear Panel

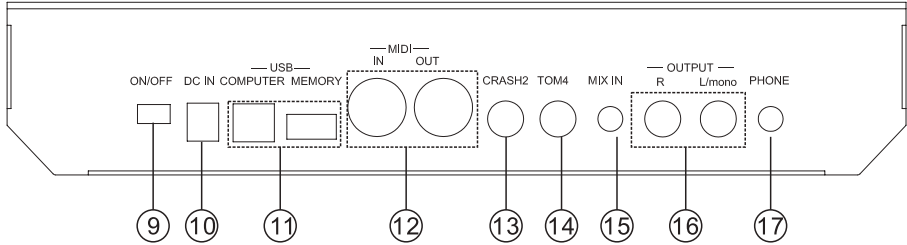

Number	Name	Description
⑨	ON/OFF	Switch on/off the power supply
⑩	DC-IN	Adapter connector
⑪	COMPUTER	Connect with PC connector (MIDI input/output via USB)
	MERMORY	Connect with USB memory: play the audio document or save it to the memory
⑫	IN-MIDI-OUT	Connect with the external connector of other device which has MIDI
⑬	CRASH2	Connect with CRASH2
⑭	TOM4	Connect with TOM4
⑮	MIX IN	Connect with digital audio player or used as the monitor input of the live playing
⑯	R L/mono	The stereo output connector connecting audio system or drum amplifier; divided into left and right channel; can independently connect with mono cable;
⑰	PHONE	Stereo headphone output connector

CONNECTING WITH EXTERNAL DEVICES

1. Connect with audio system or drum amplifier

When connecting with audio system or drum amplifier, use a cable to connect with L/mono R of the audio system and the drum amplifier.

Note:

- 1). Connect with L/mono connector when connecting with mono audio device.
- 2). Connect with L/mono and R connector when connecting with stereo audio device.
- 3). The volume is controlled by the master volume knob of module and of the audio device.

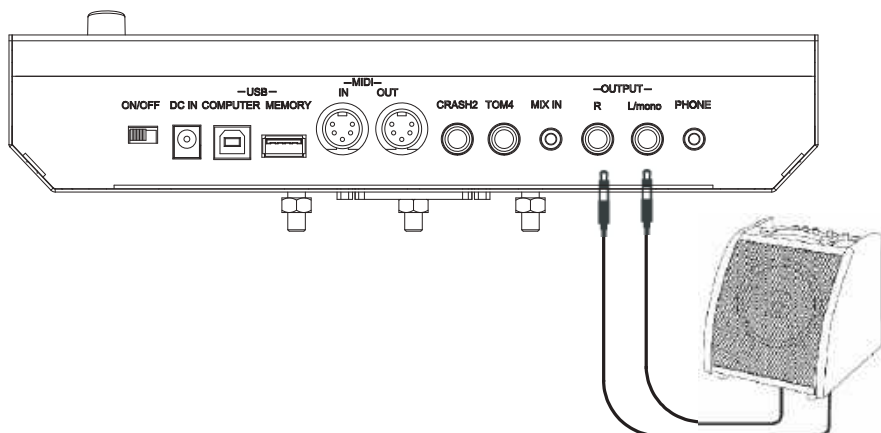

2. Connect with headphone

The module is designed with 1/8" stereo headphone connector. The volume can be adjusted via the master volume knob on the module panel or that of the headphone.

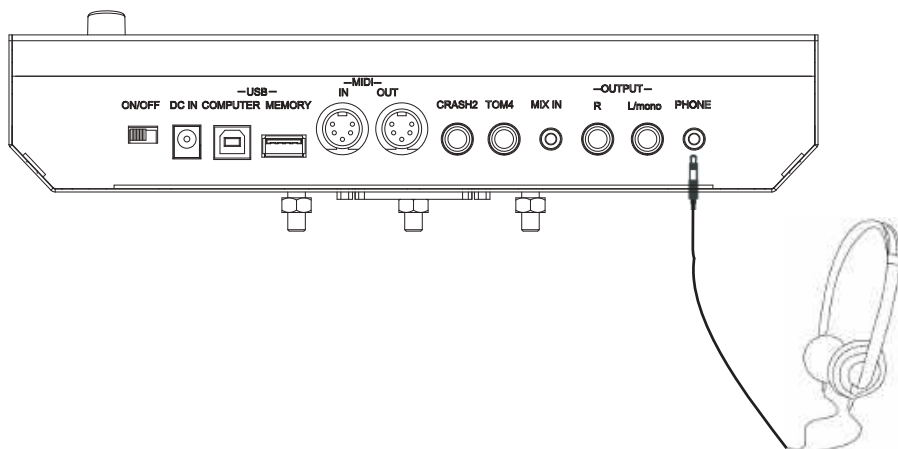

3. Connect with MP3 or CD player

Connect the output of MP3 or CD player or other audio sources with AUX.IN connector. The input signal can be mixed with the drum signal, strike the pads according to the rhythm of the input signal.

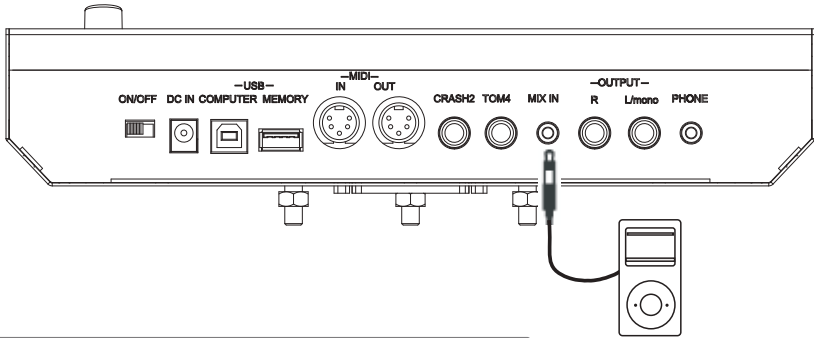

4. Connect with computer

1). Connect computer via USB: receive or send MIDI signal

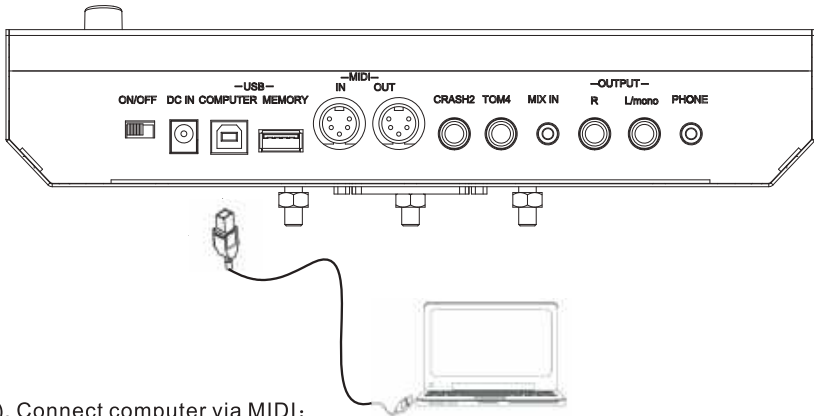

2). Connect computer via MIDI:
MIDI IN: receive the MIDI signal from computer.
MIDI OUT: transmit pad signal to computer.

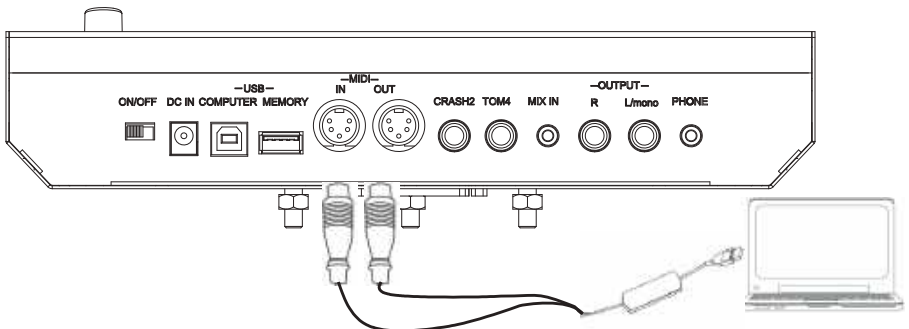

5. Connect with MIDI keyboard

If external keyboard or MIDI device are used to control the drum, it needs MIDI cable (one end) connecting with MIDI IN of the module, and (the other end)with MIDI OUT of the MIDI keyboard.or midi device, this drum is used as audio source.

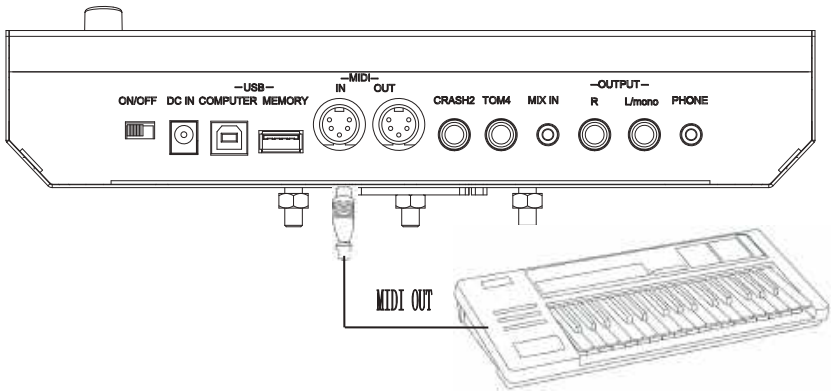

6. Connect with power supply

- 1). Set the module switch to OFF.
- 2). Plug the power adapter into DC IN connector.
- 3). Connect all the pads well, and set the module volume to minimum. Turn on the power switch, then the module starts to work.

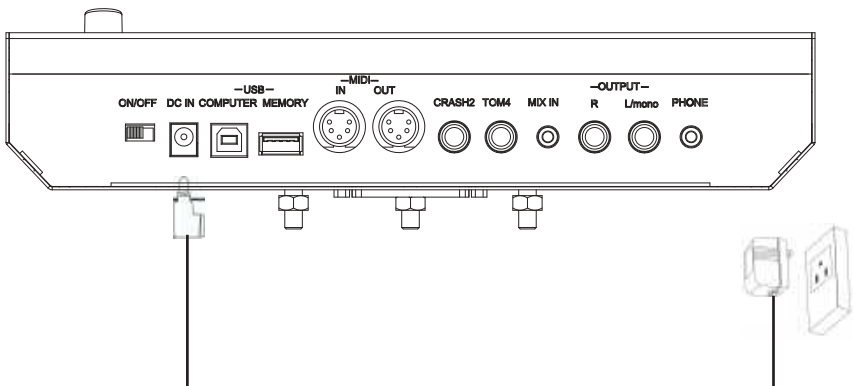



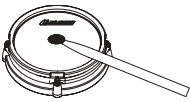
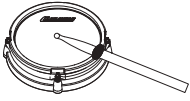
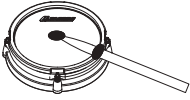

Note: Set the module switch to OFF when the module is connecting with external devices.

PERFORMANCE



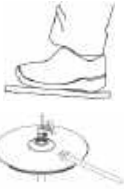

1. Trigger

Performance way	Diagram	Description
Pad shot	 A top-down diagram of a snare drum. A drumstick is shown striking the center of the drumhead, which is marked with a small black dot representing the pad.	Only striking the pad
Rim shot	 A top-down diagram of a snare drum. A drumstick is shown striking the edge of the drumhead, which is marked with a small black dot representing the rim.	Only striking the rim; different sound from that of the pad (rim shot voice)
Pad and rim shot simultaneously (only snare)	 A top-down diagram of a snare drum. A drumstick is shown striking both the center pad and the rim of the drumhead, which are both marked with small black dots.	Pad and rim shot simultaneously. Different sound from that of pad or rim.

2. Hi-hat

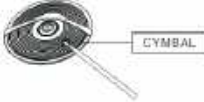

Performance way	Diagram	Description
open cymbal		Open cymbal voice: striking the hi-hat directly.
closed cymbal		Closed cymbal voice: step down the pedal and strike the hi-hat at the same time.
half open cymbal		half open cymbal voice: half step down the pedal and strike the hi-hat at the same time.
1/4 open cymbal		1/4 open cymbal: step down the pedal, but not firmly, and strike the cymbal.
Step down the pedal		Step down the pedal and keep it closed
SPLASH		Step down the pedal and release quickly

3. Cymbal

performance way	Diagram	Description
pad shot		Striking the central part of the cymbal
rim shot		Striking the cymbal rim (different sound)
Striking cymbal cap		Striking the cymbal cap (only ride)
Mute cymbal		After striking the cymbal, hold the cymbal to mute (Note: the cymbal sensor position)

BASIC OPERATION

1. Change the value

performance way	Diagram	Description
Direction button		Move the cursor
+/- button		Change kit, press 【+】 to increase and 【-】 to decrease value
Knob	 ADJUST	When the cursor is moved to the character, turn the knob to change value.

2. Select to edit the trigger

Strike the trigger pad or rim to edit the relative voice parameter.

3. Using fader

1). Fast push any fader to enter into mixer setting interface to adjust the volume of trigger or others.

Note: 3 seconds of no operation will return to drum kit interface;

2). Using **【SELECT】** to select the voice group, and the LED upper right or lower right of the fader lights up.

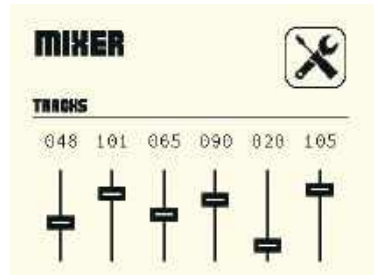
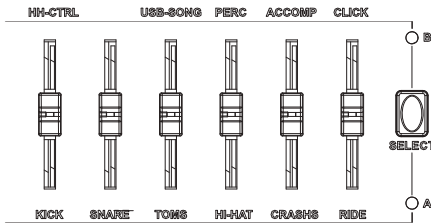

- 3). After **【SELECT】** button is used, the fader will not move to the relative volume position, user has to move the fader a little bit;
- 4). Press **【MIX OFF】** and hold for 3 seconds, it returns to preset volume.

4. Normal mode and coach mode switching

Press **【COACH】** button to switch normal mode and coach mode. After switching, the relative mode LED lights up.

NORMAL mode

1). Drum kit

Use **【+】** / **【-】** or knob to change drum kit, the screen shows the changed name of drum kit, LED shows the changed number; Simultaneously press **【+】** and **【-】** to reset.



A. Basic parameters setting

Parameter	Value	Description
TEMPO	30~250	
CLICK BEAT	0~4	Meter
X-STICK	OFF/ON	Tom rim trigger control: "OFF"(default) means TOM rim triggered, "ON" means TOM rim not triggered
DRUM	OFF/ON	Demo song drum sound: "ON" or "OFF"

B. EFFECT SETTING

Refer to the "Effect" setting in "Utility Setting"

2). VOICE

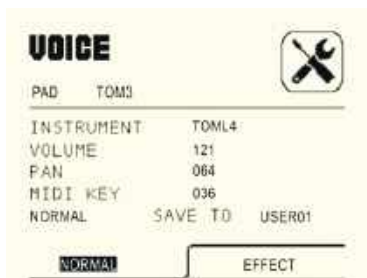

Parameter	Value	Description
NORMAL		
INSTRUMENT	1~408	
VOLUME	0~127	
PAN	0~127	sound field
MIDI KEY	0~127	Corresponding MIDI key output
EFFECT		
FILTER	0~127	Low pass filter
REVERB	0~127	
PITCH SHIFT	-5 ~ +5	transpose

Note:

- Save corresponding drum kit parameter after change to user drum kit(USER01-20);
- Import user drum kit information to USB stick(refer to USB STORAGE for details);
- Simultaneously press **【+】** and **【-】** to reset
- press **【<】** / **【>】** to switch to left or right.

3). DEMO SONG



Parameter	Value	Description
TEMPO	30~250	
ACMP	0~127	Accompaniment volume
PREC	0~127	Track volume
VOLUME	0~127	Overall volume of click, "0" means "OFF"

Note:

- Meter type is not changeable;
- Simultaneously press **【+】** and **【-】** to reset

COACH:

RHYTHM / BEAT / PATTERN



Parameter	Value	Description
TEMPO	30~250	
COACH	OFF	COACH: OFF(default); when ON, SCORE function is enabled.
SCORE		It records correct striking quantity.
VOLUME	0~127	Overall volume of click, "0" means "OFF"

Note:

- Meter type is not changeable;
- Simultaneously press **【+】** and **【-】** to reset.

UTILITY SETTING

Press **【UTILITY】** to enter into the UTILITY setting interface to select the menu in turn.
(Simultaneously press **【+】** and **【-】** to reset)



1. TRIGGER setting

In UTILITY interface, select TRIGGER via direction buttons. Press **【ENTER】** to enter into the trigger setting interface, press **【<】 / 【>】** to switch to page1 or page 2.

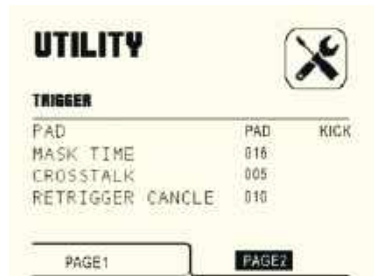
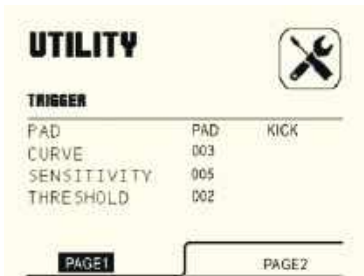

Parameter	Value	Description
TRIGGER setting		
CURVE	1~6	—
SENSITIVITY	1~16	—
THRESHOLD	1~8	the minimum force to trigger a pad signal.
MASK TIME	0~64ms	adjust the scan time span of the pad trigger
CROSSTALK	0~10	—
RETRIGGER CANCEL	0~64ms	detect the trigger signal attenuation

Description of trigger parameters

1). CURVE

Force curve: refer to Striking Force relative to Loudness, User can adjust this parameter for soft and natural feeling based on performing style.

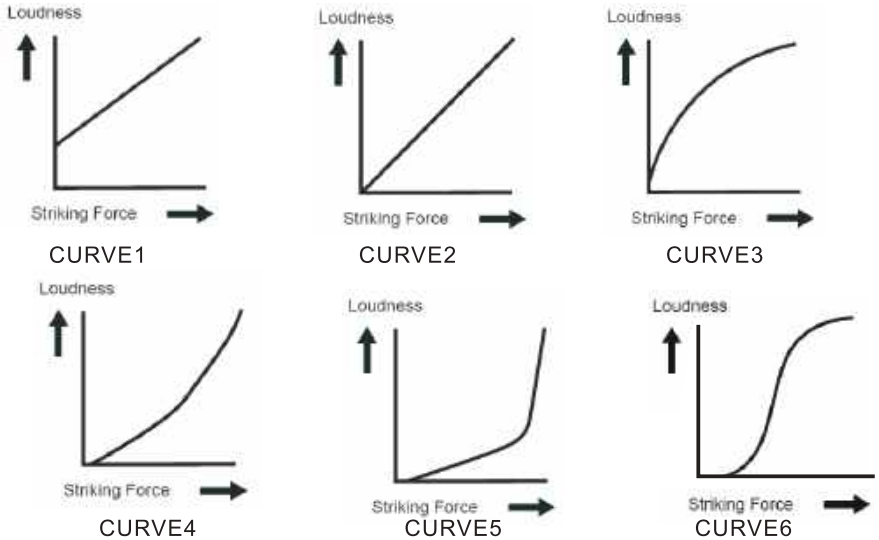

CURVE 1: Small dynamic response. Select this curve and it delivers high but stable volume.

CURVE 2: The standard setting to deliver natural signal.

CURVE 3: Compared to CURVE 2, low striking force causes big volume change.

CURVE 4: Compared to CURVE 2, comparatively high striking force causes comparatively big volume change.

CURVE 5: Compared to CURVE 2, comparatively high striking force causes very big volume change.

CURVE 6: The striking force causes extreme volume change.

2). SENSITIVITY

This parameter can adjust the trigger sensitivity. User can set the parameter according to the actual situation. The higher the parameter is, it generates higher volume. The lower the parameter is, it generates lower volume.

3). THRESHOLD

Threshold: the minimum force to trigger a pad signal.

Setting a high threshold, this pad needs a strong force to generate a signal. This can avoid accidental response, e.g. other device or pad generate unnecessary signal. Setting a low threshold, the pad needs a weak force to generate a signal.

4). MASK TIME

This parameter is used to adjust the scan time span of the pad trigger. this setting allow you to prevent double trigger

When this MASK TIME value is low, the pad is sensitive, but this will lead to repeated trigger. Please adjust this the MASK TIME value properly at this time.

When playing bass drum trigger, hammer may bounce back to strike drum pad again, causing re-trigger. Mask Time aims to prevent this problem. Once striking the drum pad, any additional trigger signal within "Mask Time" will be ignored. Adjust "Mask Time" when striking the drum pad: when using bass drum trigger, try to fast strike the drum pad after the rebound of hammer, then increase the value of "Mask Time" until no more sound is made despite the rebound of hammer.

Note:

- a. When the value is increased too much and fast striking is very hard, decrease this value as low as possible;
- b. If sound is made twice or more after one time of striking, please adjust the Retrig Cancel.

5). CROSSTALK

If two trigger are close to each other, striking one trigger has the crosstalk of another trigger. This problem can be solved via setting the crosstalk rejection ratio to a higher level. Caution: do not set the crosstalk rejection ratio to too high a level, otherwise this leads to leakage, e.g. strike two triggers simultaneously, and the trigger stroke lightly will has the leakage. Furthermore, if this parameter is set to 0, crosstalk rejection does not work.

6). Retrig Cancel: detect the trigger signal attenuation

This setting aims to prevent unreal re-trigger.

When using natural drum trigger, this setting is very important. This sort of trigger may cause AC waveform, and even accidental sound(Re-trigger) occurring to "A".

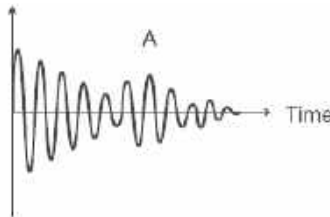

More likely, this problem occurs to waveform attenuation edge, Retrig Cancel can detect the trigger signal attenuation and prevent the re-trigger. Strike the drum pad repeatedly, increase the value of "Retrig Cancel" until no more production of re-trigger.

Note:

- a. Even if increased value can prevent re-trigger, sound may be omitted when performing fast striking operation(e.g. drum roll). Decrease this value as low as possible before re-trigger is caused.
- b. You can adjust "Mask Time" to reduce the problem. Within the specified time after receiving previous trigger signal, Mask Time will no longer detect trigger signal, Retrig Cancel will detect trigger signal attenuation and exclude unnecessary or false trigger signal.

2. CLICK setting

In UTILITY interface, select CLICK via direction buttons. Press **【ENTER】** to enter into CLICK setting interface.

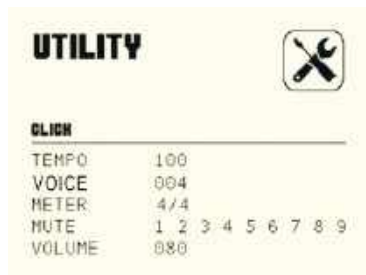

Parameter	Value	Description
CLICK setting		
TEMPO	30~250	
VOICE	4	
MUTE	1 2 3 4 5 6 7 8 9 After MUTE: 1 2 M 4 5 6 7 8 9	Use direction keys to adjust meter to be muted, and then use 【ADJUST】 knob to mute. If the meter number displays M, this means it has been muted.
VOLUME	0~127	When the parameter is set to 0, this means the CLICK is muted completely.

3. EFFECT setting

In UTILITY interface, select EFFECT via direction buttons. Press **【ENTER】** to enter into trigger effect setting interface.





Parameter	Value	Description
REVERB setting		
TYPE	ROOM1~3/HALL1~2/PLATE	Reverb type
SIZE	0~4	Size of reverb room, "0" means "OFF"
LEVEL	0~127	Reverb depth, "0" means "OFF"
TIME	0~127	Reverb delay time, "0" means "OFF"
FILTER	0~7	Low pass filter, "0" means "OFF"
EQ adjustment		
LOW FREQ	0~127	Low freq range
LOW GAIN	0~127	Boost/attenuate low freq range
HIGH FREQ	0~127	High freq range
HIGH GAIN	0~127	Boost/attenuate low freq range

4. MIDI setting

In UTILITY interface, select MIDI via direction buttons. Press **[ENTER]** to enter into MIDI setting interface.

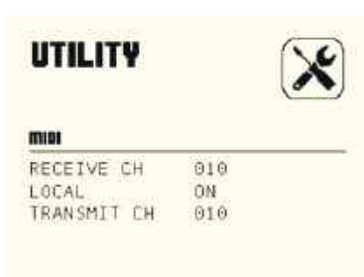

Parameter	Value	Description
MIDI setting		
RECEIVE CH	1~16	Receive channel selection,default: 10 channel
LOCAL	ON/OFF	Local control: Used for the connection between trigger and module, it defaults ON for turning on status. ON: Two modules are connected. OFF: The module does not receive the direct control of trigger, and it only receives the external MIDI input signal.
TRANSMIT CH	1~16	Output channel selection,default: 10 channel

5. COACH: the difficulty setting of coach function

In UTILITY interface, select **COACH** via direction buttons. Press **【ENTER】** to enter into coach function setting interface.

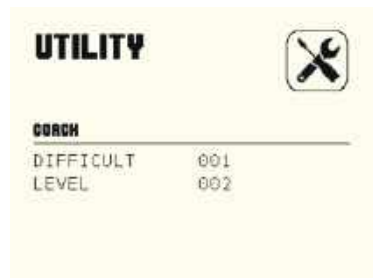

Parameter	Value	Description
COACH setting		
DIFFICULT	1~5	The higher the parameter is, the higher the difficulty is.
LEVEL	ON/OFF	The higher the parameter is, the higher the level is.

6. USB STORAGE setting

In UTILITY interface, select **USB STORAGE** via direction buttons. Press **[ENTER]** to enter into USB function setting interface (insert USB) ; if USB is not inserted, it displays USB DISCONNECTED.



- 1). **PLAY MEDIA**: it can play the MP3 or WMA format songs in USB as accompaniment one by one automatically;

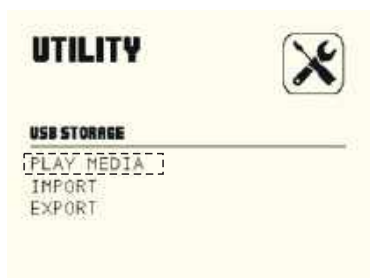

Note:

- a. LCD only displays the current song. User can use knob to change song;
- b. Song names are "words" or "numbers".

- 2). **IMPORT**: USB memory loaded into module.



A. RECORD SECTION: It inputs the real time record information;



B. SYSTEM SETTING: Imports USB user drum kit data to replace the user drum kit data in the module.



3). EXPORT: Exports user drum kit data to USB stick

In this interface, press **[ENTER]** to enter into output interface, it starts to export, and displays: Export System.....; after the export finished, it displays: Export System data OK.





7. SYSTEM setting

In UTILITY interface, select SYSTEM via direction button, press **[ENTER]** to enter into system setting interface.

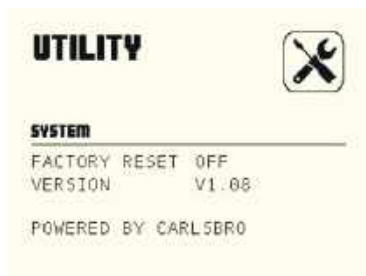

- 1). FACTORY RESET: Resets the user drum kit to factory setting. It defaults “OFF”.
- 2). VERSION: It displays the version number.

EDIT AND SAVE USER DRUM KIT

1. Drum kit information

The drummer can select different type of drum kit to play. This digital drum has 50 drum kits.

30 preset drum kits: KIT1-30

20 user drum kits: USER01-20

2. Edit and save drum kit voice

1). VOICE selection interface

In normal mode (NORMAL LED lights up), press **[VOICE]** button to enter into INSTRUMENT (voice) selection.

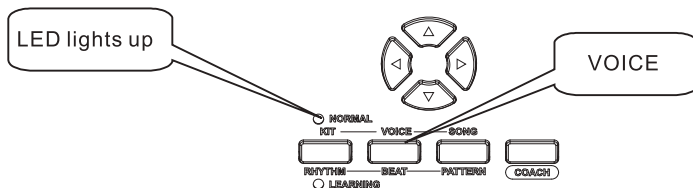

- 2). TRIGGER selection Directly strike the trigger to select.
- 3). VOLUME adjustment:

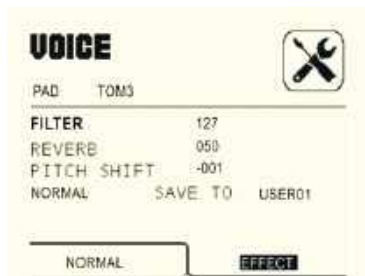
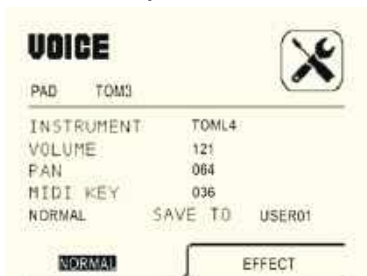

- A. INSTRUMENT: Voice selection;
- B. VOLUME: Change volume level;
- C. PAN: Sound field adjustment;
- D. MIDI KEY: MIDI key selection;
- E. FILTER: Low pass filter;
- F. REVERB: Reverb adjustment;
- G. PITCH SHIFT: Transpose adjustment.

Note: Use **【ADJUST】** knob to adjust the parameters.

- 4). Save user drum kit:

After drum parameters being adjusted, switch to SAVE TO USER01 item. Use **【ADJUST】** knob to select the user drum kit number you want to save, then press **【SAVE】** .

- 5). Save user drum kit to USB

- A. Insert USB;
- B. Press **【UTILITY】** to enter into utility setting interface;



- C. In UTILITY interface, use direction buttons to select USB STORAGE, then press **【ENTER】** button to enter into USB setting interface;



- D. Use direction buttons to select EXPORT, then press **【ENTER】** button to enter into EXPORT interface, then press **【ENTER】** button to export the user drum kit data.



3. Import from USB to user drum kit

- 1). Press **【UTILITY】** to enter into the utility setting interface;



- 2). In UTILITY interface, use direction buttons to select USB STORAGE, then press **【ENTER】** button to enter into USB setting interface;



3).Use direction button to select IMPORT, then press **【ENTER】** button to enter into import interface;



4).Use direction buttons to select SYSTEM SETTING, then press **【ENTER】** to import USB user drum kit information.



4. Set user drum kit back to factory mode

1).Press **【UTILITY】** to enter into utility setting interface;



- 2). In UTILITY interface, use direction buttons to select SYSTEM, then press **【ENTER】** button to enter into system setting interface;

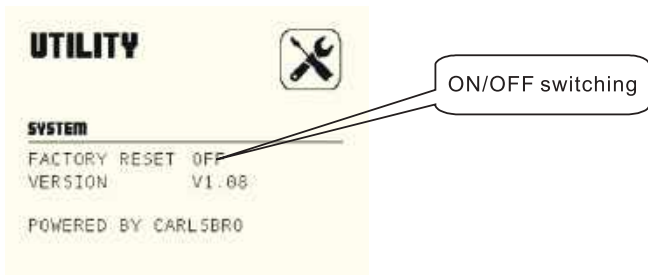

- 3). Switch to FACTORY RESET, and switch OFF status to ON, then it goes back to factory setting.

PLAYING SONGS

20 built-in DEMO SONGs

- 1). In NORMAL status (NORMAL LED lights up), press **【SONG】** button to enter into DEMO SONG;

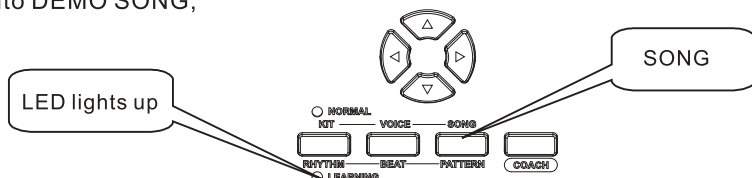

- 2). Press **【▶/■】** button to play DEMO SONG;
- 3). Press **【ADJUST】** knob to switch the song in DEMO SONG;
- 4). Press **【▶/■】** button to stop DEMO SONG playing;
(DEMO SONG refers to DEMO SONG LIST)
- 5). Adjust DEMO SONG accompaniment and drum track volume:
- Fast push fader to enter into mixer setting interface to adjust the volume of trigger or others.
 - Use **【SELECT】** button to select B voice group. LED on the right lower position of fader lights up;

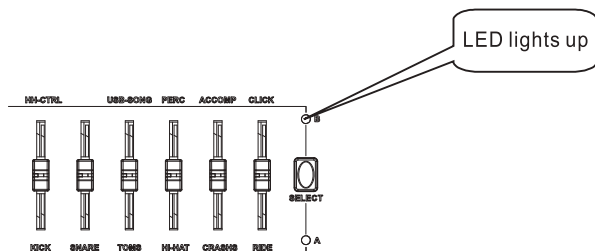

C. Fast push PERC to adjust drum track volume; push ACCOMP to adjust accompaniment track volume.

Note: The value displayed on LCD is not definitely the real volume value. User needs to move the fader a little bit first, then the fader position corresponds to the volume level, then user can adjust the volume level.

6). Mute DEMO SONG drum track:

A. During playing DEMO SONG, press **【DRUM OFF】** button to turn on or off the mute function. When this function is turned on, DRUM OFF LED lights up.

B. Fast push PERC fader to the lowest position.

RECORDING FUNCTION

This module has recording function to record user performance. Insert USB , this information can be saved to USB. If there is no USB , then the system record at real time, but it can not be saved after the system is turned off.

1. Record without USB

1). Press **【REC】** button to enter into record mode interface. LED lights up, and then set the tempo, beat.



A. TEMPO to set CLICK tempo

B. CLICK: Beat setting

C. VOLUME: CLICK VOLUME

2). Press **【REC】** button again. CLICK is turned on and LED lights up. strike pad to record.

3). Stop recording: press **【REC】** button again. LED lights off, and it stops recording.

2. USB recording

- 1). Insert USB , and set CLICK tempo, beat ;
- 2).Press **【REC】** button again. CLICK is turned on and LED lights up, strike pad to record;
- 3).Stop recording: press **【REC】** button again. LED lights off. It stops recording.
- 4).Press **【SAVE】** to save the recorded information to USB



3. Replay the recorded information

- 1).Replay the recorded information
 - A. Press **【PLAY】** button to replay the recorded information.
 - B. Press **PLAY】** button again to stop playing.
- 2). Connect USB to play the recorded information
 - A. Press **【UTILITY】** button to enter into UTILITY setting interface.
 - B. In UTILITY interface, use direction keys to select USB STORAGE. Press **【ENTER】** button to enter into USB setting interface.



C. Use direction keys to select IMPORT. Press **【ENTER】** button to enter into USB STORAGE-IMPORT setting interface.



D. Use direction keys to select RECORD SECTION. Press **【ENTER】** button to enter into real time recording import interface.



- Use **【ADJUST】** knob to switch recording order;
- Press **【PLAY】** to replay the recorded information;
- Press **【PLAY】** again to stop the recording.

COACH MODE

This coach mode goes from easy level to difficult level step by step to cultivate the user's feeling and speed and accuracy and to coordinate the user's feet and hands. The module has 20 songs for practice. The user can practise according to actual status. There are 10 rhythm songs/10 snare songs/10 drum kit songs.

1. Coach mode level selection

In UTILITY interface, use direction keys to select COACH. Press **【ENTER】** button to enter into coach function setting interface.



Note: a. DIFFICULT coefficient 1-5. The bigger the number is, the more difficult it is.
b. LEVEL 1-5. The bigger the number is, the higher the level is.

2. Enter into coach mode

Press **【COACH】** button to enter into coach mode. LED at LEARNING position lights up. Press **【RHYTHM】** / **【BEAT】** / **【PATTERN】** to enter into rhythm practice/snare practice/drum kit practice.

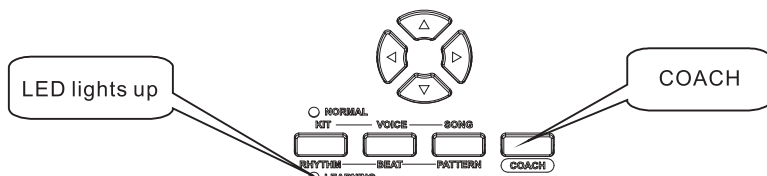

Note: When COACH is OFF, user can only listen and practise the wanted songs. When COACH is ON, it can recording the striking quantity during practice.

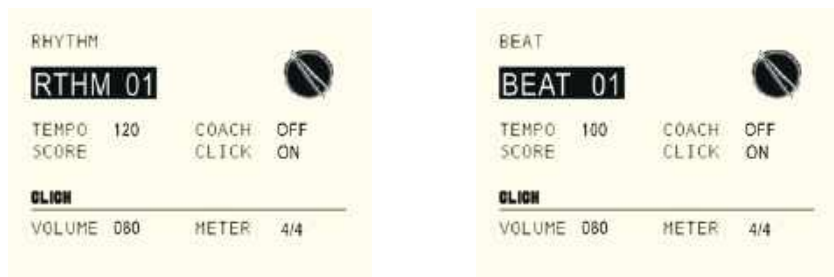

Note of parameters:

- A. TEMPO: the tempo of practice songs. Use **【ADJUST】** knob to change the song tempo.
- B. VOLUME: the CLICK volume. Use **【ADJUST】** knob to adjust volume.
- C. CLICK: meter is the preset demo song, and can not be changed.

3. Select song

In the coach interface, use 【ADJUST】 knob to change the practice song number.

4. Play/stop

Press 【▶/■】 button to play. Press 【▶/■】 again to stop playing.

5. Play with the song and record

When playing DEMO SONG or pattern, press 【REC】 button to enter into recording status. Press 【REC】 button again. LED flashes and recording starts. It records the drum of song and the striking. Press 【REC】 button to stop recording.

Note:

- a. Insert USB and record: the recorded data (MIDI format) is saved in USB.
- b. Record without USB: real time recording.

MIDI SETTING

This drum is compatible with various MIDI device, the drum is used as trigger device or the module. When it is compatible with GM standard part, it can be used with audio sequence software together.

1. About MIDI

MIDI IN: input MIDI signal when connected with external MIDI device.

MIDI OUT: output MIDI signal when connected with external MIDI equipment.

USB: This device has standard USB2.0 interface to connect with any MIDI device or PC with standard USB drive. The operation system has relative drive without the need of repeated installation, and compatible with PC system, e. g. Windows compatible from XP to Win10, Mac OSX. After connection, the system will identify this device as EDRUM
(USB MIDI is used only when connected with MIDI)

Note: When USB MIDI is connected with PC, all MIDI data can be received or transmit via USB MIDI.

2. MIDI setting

In UTILITY interface, use direction keys to select MIDI, press **【ENTER】** button to enter into MIDI setting interface.

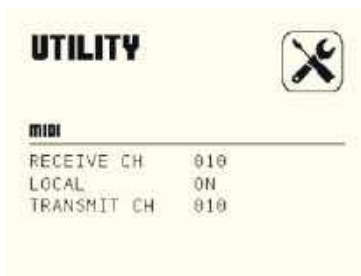

- A. RECEIVE CH: input channel selection 1-16, default: 10 channel
- B. LOCAL: local control, used to control the connection with trigger or module.
Local mode ON (ON) : The pads and sound module are connected. It sounds when user strikes the pads. It defaults ON status.
Local mode OFF (OFF): The pads and sound module are disconnected. It does not sound when user strikes the pads.
- C. TRANSMIT CH: output channel selection 1-16, default: 10 channel

3. Connect with external audio source equipment

This device can transmit pad information via channel 10 automatically, including trigger note、strength、hi-hat pedal performance and status, etc;
(Note: The saved song playing or CLICK information can not be transmitted)

- 1). Use external audio sequencer to record performance
 - A. Connect with MIDI IN of external audio sequencer via MIDI OUT connector or USB interface. If PC audio sequence software is used, it only needs one USB A-B cable to connect PC with audio source module;
 - B. The audio sequencer or audio sequence software recognizes the channel 10 as this default device , and starts to record;
 - C. Perform the pads;
 - D. Stop performance and recording;
 - E. The performance can be played again.
- 2). Set pad MIDI output note
 - Each trigger can set MIDI output note. Each drum kit can save one MIDI output note for convenient application. Generally user does not need to change the default MIDI note. If user wants to, please follow the following steps:
 - A. In normal mode (NORMAL LED lights up) , press **【VOICE】** button to enter into voice setting interface.

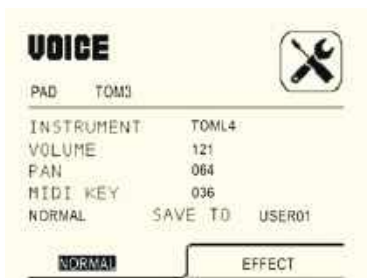

- B. Use direction keys to switch to MIDI KEY. Use **【ADJUST】** knob to change the relative MIDI note of each trigger.
(select the trigger to be edited via striking trigger)
- C. Use direction keys to switch to SAVE TO USER01. Use **【ADJUST】** knob to select user drum kit number. Press **【SAVE】** button to save the changed MIDI output note to the user drum kit.

Preset MIDI note

Trigger	Note	Trigger	Note	Trigger	Note	Trigger	Note	Trigger	Note
KICK	36	TOM2	45	TOM4 R	47	CRASH2	59	HI-HAT C	42
SNARE	38	TOM2 R	64	RIDE	51	CRASH2 R	52	HI-HAT P	44
SNARE R	37	TOM3	43	RIDE R	57	HI-HAT O	46	SPLASH	46
TOM1	47	TOM3 R	63	CRASH1	49	HI-HAT HO	46		
TOM1 R	56	TOM4	41	CRASH1 R	55	HI-HAT 1/4 O	46		

4. Used as audio source device

Connect MIDI OUT or USB cable with external MIDI keyboard or audio sequencer to receive MIDI output signal. This device can play the signal. The output voice changes when drum kit switches. This device has most of the GM drum kit voices. If user want to establish USER drum kit, please refer to MIDI list.

5. MIDI list

FUNCTION		TRANSMITTED	RECOGNIZED	REMARKS
BASIC CHANNEL	DEFAULT CHANGED	10 Ch 1-16	1-16 1-16	
MODE	DEFAULT MESSAGES ALTERED	x x *****	x x *****	
NOTE MEMBER:	TRUE VOICE	0-127 *****	0-127 0-127	
VELOCITY	NOTE ON NOTE OFF	O 9nH,V=1-127 X (9nH,V=0)	o o	
AFTER TOUCH	KEY'S CH'S	x x	x x	
PITCH BEND		x	x	
CONTROL CHANGE		0 x 1 x 5 x 6 x 7 x 10 x 11 x 64 x 65 x 66 x 67 x 80 x 81 x 91 x 93 x 120 x 121 x 123 x	o o o o o o o o o o o o o o o o o o	BANK SELECT MODULATION PORTAMENTO TIME DATA ENTER VOLUME PAN EXPRESSION SUSTAIN PEDAL PORTAMENTO ON/OFF SOSTENUTO PEDAL SOFT PEDAL REVERB PROGRAM CHROUS PROGRAM REVERB LEVEL CHROUS LEVEL ALL SOUNDS OFF RESET ALL CONTROLLERS ALL NOTES OFF
PROGRAM CHANGE	TRUE NUMBER	o *****	o 0-127	
SYSTEM EXCLUSIVE		x	o	
SYSTEM COMMON	: SONG POSITION : SONG SELECT : TUNE	x x x	x x x	
SYSTEM REAL TIME	: CLOCK : COMMANDS	o o	x x	START AND STOP ONLY
AUX MESSAGE	: LOCAL ON/OFF : ALL NOTES OFF : ACTIVE SENSING : RESET	x x o x	x x x x	

Trouble shooting

Problem	Reason
No sound or too low volume	Please confirm if the volume knob is set properly, and adjust the volume knob (MIX IN、PHONES、MASTER) .
	Check if the cable connecting audio source and power amplifier is connected correctly. User can change a cable to test.
	If a mixer is connected with reinforcement equipment, please use a good headphone to connect with the module. If there is sound, please check if the cable is connected well, or if the cable between mixer and reinforcement equipment is connected well.
Pad has no sound	Please confirm the cable between pad and module is connected well.
	Check the setting---if LOCAL is set to OFF. if LOCAL is set to OFF, the pad has no sound when being stroke.
	Check if the pad volume is set to 0.
CLICK has no sound	Check if the CLICK volume is set to 0.
DEMO SONG has no sound	Check if the DEMO SONG volume is set to 0.
The system can not identify USB	Check if the USB is good, or if USB is connected well with the module. It is recommended to use the USB below 32G.
The USB audio documents can not be played	The module now only supports MP3 & WMA format audio document.
	Please save the audio documents which this equipment supports to USB root directory.
Connecting MIDI equipment but no sound	Check if the MIDI cable for connection is good.
	Check if the connection port is connected well, if the module MIDI out connector and other MIDI equipment input connector are connected well, If module MIDI in connector and other MIDI equipment are connected well.
	Please check if the communication channel is correct. The module sets the communication channel is channel 10

Module specification

Max polyphony: 64

Display: Pixel320X240, large TFT

Voice: 408 drum and percussion voices +128 GM voices

Drum kit: 30 Preset drum kits + 20 User drum kits

Effects:

- 1) 2 band EQ setting (high/low) /GAIN adjustment
- 2) Reverb setting: 6 kinds of reverb setting (room1, room2, room3, hall1, hall2, plate) , REVERB ROOM 0-4/REVERB DEPTH 0-127/REVERB TIME 0-127/ FILTER 0-7

Audio sequencer:

- 1) One track recording 1000 notes
- 2) One track percussion recording can be output to USB.
- 3) Normal mode: 20 preset songs
Coach mode: 10 rhythm practice/10 snare practice /10 pattern practice
Level: 1-5 difficulty: 1-5

CLICK function:

- 1) Click voice: 4 kinds
- 2) Click tempo range: 30-250 adjustable
- 3) Click: 1/4-9/4
- 4) Click mute function

Connector:

Headphone stereo out connector (1/8"), MIX IN stereo connector (1/8"),
Audio out connector (1/4" L/mono R)、USB MIDI、USB COMPUTER、MIDI IN、
MIDI OUT connector

Extension:TOM4、CRASH2

Due to product updates, equipment parameters or appearance are subject to changes without prior notice

Drum kit list

Number	Name	Number	Name
1	ROCK	16	BLUES
2	FUNK/POP	17	CUBAN
3	JAZZ	18	BRUSH1
4	LATIN	19	BRUSH2
5	DANCE	20	LIVE
6	POP1	21	ELE1
7	POP2	22	ELE2
8	POP3	23	GMDRUM
9	HARD ROCK	24	CNTRY
10	METAL	25	ORCH1
11	FUNK1	26	ORCH2
12	FUNK2	27	SONGGU
13	FUNK3	28	WORLD
14	FUSION	29	PERC.1
15	PUNK	30	PERC.2

VOICE

KICK	
1	KICK01
2	KICK02
3	KICK03
4	KICK04
5	KICK05
6	KICK06
7	KICK07
8	KICK08
9	KICK09
10	KICK10
11	KICK11
12	KICK12
13	KICK13
14	KICK14
15	KICK15
16	KICK16
17	KICK17
18	KICK18
19	KICK19
20	KICK20
21	KICK21
22	KICK22
23	KICK23
24	KICK24
25	KICK25
26	KICK26
27	KICK27
28	KICK28
29	KICK29
30	KICK30
31	KICK31
32	KICK32
33	KICK33
34	KICK34
35	KICK35
36	KICK36
37	KICK37
38	KICK38
39	KICK39
SNARE	
40	SNARE01
41	SNARE02
42	SNARE03
43	SNARE04
44	SNARE05
45	SNARE06
46	SNARE07

47	SNARE08
48	SNARE09
49	SNARE10
50	SNARE11
51	SNARE12
52	SNARE13
53	SNARE14
54	SNARE15
55	SNARE16
56	SNARE17
57	SNARE18
58	SNARE19
59	SNARE20
60	SNARE21
61	SNARE22
62	SNARE23
63	SNARE24
64	SNARE25
65	SNARE26
66	SNARE27
67	SNARE28
68	SNARE29
69	SNARE30
70	SNARE31
71	SNARE32
72	SNARE33
73	SNARE34
74	SNARE35
75	SNRIM1
76	SNRIM2
77	SNRIM3
78	SNRIM4
79	SNRIM5
80	SNRIM6
81	SNRIM7
82	SNRIM8
83	SNRIM9
84	SNRIM10
85	SNRIM11
86	SNRIM12
87	SNRIM13
88	SNRIM14
89	SNRIM15
90	ESNR1
91	ESNR2
92	ESNR3
93	ESNR4
94	ESNR5

95	ESNR6
96	ESNR7
97	ESNR8
98	ESNR9
99	ESNR10
HIHAT	
100	CLHIHAT1
101	CLHIHAT2
102	CLHIHAT3
103	CLHIHAT4
104	CLHIHAT5
105	CLHIHAT6
106	CLHIHAT7
107	CLHIHAT8
108	CLHIHAT9
109	CLHIHAT10
110	CLHIHAT11
111	CLHIHAT12
112	CLHIHAT13
113	CLHIHAT14
114	CLHIHAT15
115	CLHIHAT16
116	CLHIHAT17
117	CLHIHAT18
118	CLHIHAT19
119	CLHIHAT20
120	CLHIHAT21
121	CLHIHAT22
122	PDLHHT1
123	PDLHHT2
124	PDLHHT3
125	PDLHHT4
126	PDLHHT5
127	PDLHHT6
128	PDLHHT7
129	PDLHHT8
130	PDLHHT9
131	PDLHHT10
132	PDLHHT11
133	PDLHHT12
134	PDLHHT13
135	PDLHHT14
136	PDLHHT15
137	PDLHHT16
138	PDLHHT17
139	PDLHHT18
140	PDLHHT19
141	PDLHHT20

142	PDLHHT21
143	PDLHHT22
144	OPNHHT1
145	OPNHHT2
146	OPNHHT3
147	OPNHHT4
148	OPNHHT5
149	OPNHHT6
150	OPNHHT7
151	OPNHHT8
152	OPNHHT9
153	OPNHHT10
154	OPNHHT11
155	OPNHHT12
156	OPNHHT13
157	OPNHHT14
158	OPNHHT15
159	OPNHHT16
160	OPNHHT17
161	OPNHHT18
162	OPNHHT19
163	OPNHHT20
164	OPNHHT21
165	OPNHHT22
166	HOPNHHT01
167	HOPNHHT02
168	HOPNHHT03
169	HOPNHHT04
170	HOPNHHT05
171	HOPNHHT06
172	HOPNHHT07
173	HOPNHHT08
174	HOPNHHT09
175	HOPNHHT10
176	HOPNHHT11
177	HOPNHHT12
178	LSHHT1
179	LSHHT2
180	LSHHT3
181	LSHHT4
182	LSHHT5
183	LSHHT6
184	LSHHT7
185	LSHHT8
186	LSHHT9
187	LSHHT10
188	LSHHT11
189	LSHHT12

190	ELCHHT1
191	ELCHHT2
192	ELCHHT3
193	ELCHHT4
194	ELCHHT5
195	ELCHHT6
196	ELCHHT7
197	ELCHHT8
TOM	
198	TOMH1
199	TOMH2
200	TOMH3
201	TOMH4
202	TOMH5
203	TOMH6
204	TOMH7
205	TOMH8
206	TOMH9
207	TOMM1
208	TOMM2
209	TOMM3
210	TOMM4
211	TOMM5
212	TOMM6
213	TOMM7
214	TOMM8
215	TOMM9
216	TOML1
217	TOML2
218	TOML3
219	TOML4
220	TOML5
221	TOML6
222	TOML7
223	TOML8
224	TOML9
225	TOME1
226	TOME2
227	TOME3
228	TOME4
229	TOME5
230	TOME6
231	TOME7
CYMBAL	
232	CRASH1
233	CRASH2
234	CRASH3
235	CRASH4
236	CRASH5

237	CRASH6
238	CRASH7
239	CRASH8
240	CRASH9
241	CRASH10
242	CRASH11
243	CRASH12
244	CRASH13
245	CRASH14
246	CRASH15
247	CRASH16
248	CRASH17
249	CRASH18
250	CRASH19
251	CRASH20
252	CRASH21
253	CRASH22
254	CRASH23
255	CRASH24
256	CRASH25
257	CRASH26
258	CRASH27
259	CRASH28
260	CRASH29
261	CRASH30
262	CRASH31
263	CRASH32
264	CRASH33
265	CRASH34
266	CRASH35
267	CRASH36
268	RIDE1
269	RIDE2
270	RIDE3
271	RIDE4
272	RIDE5
273	RIDE6
274	RIDE7
275	RIDE8
276	RIDE9
277	RIDE10
278	RIDE11
279	RIDE12
280	RDBELL1
281	RDBELL2
282	RDBELL3
283	RDBELL4
284	RDBELL5
285	RDBELL6

286	RDBELL7
287	RDBELL8
288	RDBELL9
289	RDBELL10
290	RDBELL11
291	RDBELL12
292	ELCCRSH1
293	ELCCRSH2
294	ELCCRSH3
295	ELCCRSH4
296	ELCCRSH5
297	ELCCRSH6
PERCUSSION	
298	HI_Q
299	SLAP
300	SCRTCH1
301	SCRTCH2
302	STICK
303	SQ_CLICK
304	CLICK
305	BELL
306	CLAP1
307	CLAP2
308	CLAP3
309	TAMBRINE
310	COWBELL1
311	COWBELL2
312	COWBELL3
313	COWBELL4
314	COWBELL5
315	ECOWBELL1
316	ECOWBELL2
317	ECOWBELL3
318	VSLAP
319	HIBONGO
320	LOBANGO
321	MUTECONGA1
322	MUTECONGA2
323	HICONGA1
324	HICONGA2
325	LOCONGA1
326	LOCONGA2
327	HSTIMBLH
328	TBLH3
329	TBLH3
330	HSTIMBL
331	TBL2
332	TBL3
333	HIAGOGO

334	LOAGOGO
335	CABASA
336	MARACAS
337	WHISTLE_S
338	WHISTLE_S2
339	WHISTLE_L
340	WHISTLE_L2
341	GUIRO_S
342	GUIRO_L
343	CLAVE1`
344	CLAVES
345	WBLK_H
346	WBLK_L
347	CUICA_M
348	CUICA_O
349	CUICA_O2
350	MTRIANGLE
351	OTRIANGLE
352	SHKR1
353	SHKR2
354	JNGLBL
355	BLLTREE
356	CSTNTS1
357	CSTNTS2
358	SURDO_M
359	SURDO_O
360	TLKNDML
361	TLKNDMH
362	TABLA1
363	TABLA2
364	SNAP
365	AFRCHNDDM1
366	AFRCHNDDM2
367	AFRCHNDDM3
368	CAJON1
369	CAJON2
370	CAJON3
371	TMPNI1
372	TMPNI2
373	GONG_LO
374	ELCLICKH
375	ELCLICKL
376	TAIKO
377	TAIKOS
378	BELL
379	BAN
380	SIGU
381	TANGGU1
382	TANGGU2

383	GONG1
384	PIATTI1
385	SMGONG1
386	SMGONG2
387	GONG2
388	GONG3
389	PIATTIM

390	JUNKMAN
391	BOLLY
392	ESCRACH
393	PING
394	MONO
395	MACHINE1
396	ESHAKR

397	ELCLICK3
398	TRNNAROUND
399	DOWN
400	VOCAL_1
401	VOCAL_2
402	VOCAL_3
403	VOCAL_4

404	VOCAL_5
405	VOCAL_6
406	VOCAL_7
407	VOCAL_8
408	VOCAL_9

GM drum kit list

Note No.	Standard name	Voice No.	Voice Name
27—D#1	High Q	311	High Q
28 E1	Slap	312	SLAP
29—F1	Scratch Push	313	SCRATCH PUSH
30—F#1	Scratch Pull	314	SCRATCH PULL
31—G1	Sticks	315	STICKS
32—G#1	Square Click	316	Square Click
33—A1	Metronome Click	317	METRONOME CLICK
34—A#1	Metronome Bell	318	METRONOME BELL
35—B1	Acoustic Bass Drum	1	KICKN1
36—C2	Bass Drum 1	14	KICK6
37—C#2	Side Stick	169	SD_STK3
38—D2	Acoustic Snare	132	GMSN
39—D#2	Hand Clap	360	CLAP1
40—E2	Electric Snare	165	ESN_1
41—F2	Low Floor Tom	202	TOMMSTD
42—F#2	Closed Hi Hat	50	CHH_STD
43—G2	High Floor Tom	199	TOM8
44—G#2	Pedal Hi-Hat	100	PHHN3
45—A2	Low Tom	192	TOM1
46—A#2	Open Hi-Hat	89	OHH_STD
47—B2	Low-Mid Tom	198	TOM7
48—C3	Hi-Mid Tom	197	TOM6
49—C#3	Crash Cymbal 1	234	CRSHN01
50—D3	High Tom	194	TOM3
51—D#3	Ride Cymbal 1	265	RIDEN1
52—E3	Chinese Cymbal	299	CNCYMBAL
53—F3	Ride Bell	279	RBLL_STD
54—F#3	Tambourine	446	TMBRN1
55—G3	Splash Cymbal	293	SPLSH1
56—G#3	Cowbell	375	COWBLL12
57—A3	Crash Cymbal 2	237	CRASHN04
58—A#3	Vibraslap	450	VSPL1
59—B3	Ride Cymbal 2	267	RIDEN03
60—C4	Hi Bongo	385	HIBNGO1
61—C#4	Low Bongo	390	LOBNGO1
62—D4	Mute Hi Conga	420	MHCNGA01
63—D#4	Open Hi Conga	430	OHCNGA01
64—E4	Low Conga	417	LOCNGA1
65—F4	High Timbale	394	HTMBL1
66—F#4	Low Timbale	406	LO_TMB5
67—G4	High Agogo	377	HAGOGO1
68—G#4	Low Agogo	381	LAGOGO1
69—A4	Cabasa	349	CABASA1
70—A#4	Maracas	441	MRCAS1
71—B4	Short Whistle	413	SWHSL1
72—C5	Long Whistle	411	LWHSL1

73—C#5	Short Guiro	410	SGUIRO
74—D5	Long Guiro	409	LGUIRO
75—D#5	Claves	363	CLV
76—E5	Hi Wood Block	407	HWBLK
77—F5	Low Wood Block	408	LWBLK
78—F#5	Mute Cuica	415	MCUICA
79—G5	Open Cuica	416	OCUICA
80—G#5	Mute Triangle	443	MTRNGL
81—A5	Open Triangle	444	OPNTRNGL
82—A#5	Shaker	321	SHAKER
83—B5	Jingle Bell	322	JINGLEBELL
84—C6	Bell Tree	348	BELLTREE
85—C#6	Castanets	323	CASTANETS
86—D6	Mute Surdo	324	MUTESURDO
87—D#6	Open Surdo	320	OPNSURDO

DEMO SONG LIST

Number	Name	Meter	Tempo
DEMO 01	POP ROCK	4/4	100
DEMO 02	FUNK1	4/4	120
DEMO 03	FUNK2	4/4	159
DEMO 04	ROCK BLUES1	4/4	128
DEMO 05	ROCK BLUES2	4/4	105
DEMO 06	BLUES	4/4	64
DEMO 07	HARD ROCK	4/4	138
DEMO 08	ROCK	4/4	140
DEMO 09	METAL	4/4	120
DEMO 10	POP	4/4	100
DEMO 11	SOUL	4/4	82
DEMO 12	FUSION	4/4	110
DEMO 13	COUNTRY	4/4	120
DEMO 14	COUNTRY FOLK	4/4	108
DEMO 15	FOLK	4/4	140
DEMO 16	JAZZ	4/4	130
DEMO 17	ROCK	4/4	145
DEMO 18	REGGAE	4/4	110
DEMO 19	BOSSA	4/4	120
DEMO 20	WALTZ	3/4	140

Coach mode practice song list

Number	Name	Meter	Tempo	Measure
RHYTHM				
1	RTHM 01	4/4	120	4
2	RTHM 02	4/4	100	4
3	RTHM 03	4/4	68	4
4	RTHM 04	4/4	107	4
5	RTHM 05	4/4	106	4
6	RTHM 06	4/4	106	4
7	RTHM 07	4/4	130	4
8	RTHM 08	4/4	130	4
9	RTHM 09	4/4	130	4
10	RTHM 10	4/4	105	4
BEAT				
1	BEAT 01	4/4	100	4
2	BEAT 02	4/4	100	4
3	BEAT 03	4/4	100	4
4	BEAT 04	4/4	100	4
5	BEAT 05	4/4	100	4
6	BEAT 06	4/4	100	4
7	BEAT 07	4/4	100	4
8	BEAT 08	4/4	100	4
9	BEAT 09	4/4	100	4
10	BEAT 10	3/4	100	4
PATTERN				
1	PTTN 01	4/4	108	4
2	PTTN 02	4/4	108	4
3	PTTN 03	4/4	98	4
4	PTTN 04	4/4	160	4
5	PTTN 05	4/4	125	4
6	PTTN 06	4/4	130	4
7	PTTN 07	4/4	113	4
8	PTTN 08	4/4	131	4
9	PTTN 09	4/4	125	4
10	PTTN 10	3/4	100	4

Service information

If you have a problem with your Carlsbro product or think it has developed a fault you should first carefully check the Trouble Shooting section in this guide. If this does not solve the problem or if the product is physically damaged, contact your local dealer or distributor for service details.

Should it be recommended you return the product to your nearest Carlsbro Service Centre you must first contact them.

You will be asked for the product type and serial number. You will then be given a returns Authorisation (RA) number. Pack the unit in its original carton to protect it from shipping damage.

You must have the Returns Authorisation number clearly marked on the outside of the carton or we may refuse the delivery.

Carlsbro cannot be held responsible for damage resulting from the equipment being packed incorrectly.

Label the equipment clearly with your name and address and include a clear description of the fault. The more information you supply helps the service engineer, minimising repair cost when out of warranty.

Please write your serial number here for future reference.

SCC Audio Ltd

Unit 11, Torc: MK, Chippenham Drive, Kingston,
Milton Keynes, MK10 0BZ, United Kingdom
Tel- +44(0)1908 281072

Web: www.carlsbro.com Email: info@carlsbro.com